

CRYOMECH

Liquid Helium Plant

**INSTALLATION, OPERATION and
ROUTINE MAINTENANCE MANUAL**

The information contained in this document is believed to be accurate and reliable as of the time of its publication. However, Cryomech, Inc. cannot accept any responsibility (financial or otherwise) that may result from the use or misuse of the information contained in this document. Except as expressly contained in this document, there are no other warranties granted or extended by the manufacturer.

Cryomech, Inc. reserves the right to add, change, modify or delete any or all information contained herein without prior written notice. Revisions to this document may be issued at the time such changes and/or deletions occur.

Any duplication of this manual or any of its parts without expressed written permission from Cryomech, Inc. is expressly prohibited.

Correspondence concerning this document should be forwarded to:

Customer Service Department
Cryomech, Inc.
113 Falso Drive
Syracuse, NY 13211 USA

Telephone (315) 455-2555
FAX: (315) 455-2544

Email: cryoservice@cryomech.com

Website: www.cryomech.com

Contents

Section 1
Overview

Section 2
Warranty

Section 3
Safety

Section 4
Inspection and Unpacking

Section 5
Specifications

Section 6
Installation

Section 7
Operation

Section 8
Routine Maintenance

Appendix A



Section 1

Overview

Section 1: Overview

This section provides a general overview of the Cryomech Liquid Helium Plant, the organizational structure of this manual, and a glossary of defined terms and acronyms.

1.1 Liquid helium plant

1.1.1 General description

Cryomech's Liquid Helium Plant (**LHeP**) is designed to produce liquid helium from any room temperature helium gas source with a minimum purity of **99.99%**. A standard, fully automatic, *Cryomech LHeP* consists of a *Cryomech Pulse Tube Cryorefrigerator*, a vacuum-jacketed liquid helium Dewar, a touch-screen computer interface to control and monitor overall operation, and instruments which measure and control liquid level, pressure, and temperature in the Dewar.

The cryorefrigerator consists of a cold head and a helium compressor package. The cold head is mounted in the Dewar and connected to the compressor. Room temperature helium gas supply enters the top of the Dewar through the inlet manifold, is cooled and liquefied by the heat exchangers on the cold head, and is stored as liquid helium in the bottom of the Dewar for later extraction and use.

Operation of the cryorefrigerator is based on a closed-loop helium expansion cycle that uses **99.999%** pure helium as the refrigerant. The cold head is connected by flexible stainless steel hoses (flex lines) to the helium compressor package. In the oil-lubricated compressor, a heat exchanger removes the heat and a series of oil separators and filters removes the oil from the process of helium compression. The compressed helium refrigerant is then fed to the cold head via the high-pressure helium flex line. The cold head takes the helium through multiple adiabatic expansion cycles to cool it down to liquid helium temperatures. The low-pressure helium gas remaining in the cold head is returned to the compressor package via the low-pressure helium flex line, where the cycle is repeated. The supply helium gas stream is fed into the Dewar, where it contacts the cold head heat exchangers, cooling it to a liquid for storage in the Dewar.

1.1.2 Features and benefits of Cryomech Liquid Helium Plants

Cryomech's Liquid Helium Plants have been carefully designed and manufactured to provide years of trouble free service.

Primary features

- Easy installation
- Cryomech Pulse Tube technology
- Fully automatic computer controlled operation
- Remote operation and monitoring through local area network

Primary benefits

- Requires only electrical power and cooling water
- Does not require a full time trained operator
- High reliability and long mean time between maintenance

1.2 Cryomech Liquid Helium Plant Manual

This manual introduces the complete *LHeP* system and its components. Please review it carefully before beginning the process of installation and operation.

1.2.1 Organization of the manual

The main body of this manual provides detailed information that is necessary to properly install, operate, and maintain the *Cryomech LHeP*. For ease of reference, the information is divided into 8 sections with accompanying illustrations, as needed, for clarification.

It is important to note that numbered lists (labeled 1, 2, etc.) are representative of sequential actions that must be performed in the order listed, whereas bulleted lists indicate that order is not imperative.

This manual also contains essential information for the safe and effective operation of the *Cryomech LHeP*. Section 2 explains how to avoid causing unnecessary damage to the system which can void your warranty, and section 3 clearly describes all the safety precautions to adhere to.

Sections 4 through 8 provide complete, step-by-step instructions on handling the *Cryomech LHeP*, from inspection of the packing crate to routine maintenance. Each safety precaution is also outlined in these sections in each place where observing the caution or warning is necessary.

- **Section 1:** Overview
- **Section 2:** Warranty
- **Section 3:** Safety
- **Section 4:** Inspection and Unpacking
- **Section 5:** Specifications
- **Section 6:** Installation
- **Section 7:** Operation
- **Section 8:** Routine Maintenance
- **Appendix:** Additional Information

1.3 Glossary

1.3.1 Definitions

The terms defined below are used with precision in the manual. For example, distinction is made between the helium compressor package and the helium compressor module.

The terms are in alphabetical order. Italicized text within the definitions indicate terms that are also defined in this section.

Aeroquip® Couplings:

The term "Aeroquip® couplings" is used generically to describe the self-sealing fittings that connect components, e.g. *helium flex lines* are connected to the *helium compressor package* and to the *cold head* via Aeroquip® couplings.

Category II Installation:

Category II refers to the potential for transient over-voltage conditions in the mains power connection to the equipment. See IEC 664, Sub-clause 5.6 for further details.

Closed Loop System:

This refers to a cryogenic system that has no helium loss because the helium is cycled through a closed loop. The advantage of such a system is that there is no need to add helium.

Cold Head:

The cold head is an expansion device which is capable of reaching *cryogenic temperatures*. The cold head is mounted to the top of the *Dewar*.

Cold Head Helium Condenser:

The helium condenser on the *cold head* liquefies the gaseous helium in the Dewar.

Cold Head Motor Cord:

The cold head motor cord is pre-wired and fitted with electrical connectors on each end that attach to the *cold head* and *compressor package*. The cold head motor cord provides electrical power from the *compressor package* to the *cold head* motor.

Cold Head Temperature Monitor:

The cold head temperature monitor reads the *cold head* temperature and transmits this information to the *touch screen computer*.

Cryogenic Temperatures:

Temperatures lower than 120K or -153°C.

Cryorefrigerator (Cryocooler):

A cryorefrigerator is a cryogenic refrigeration system based upon a closed loop helium expansion cycle. It consists of a *helium compressor package*, *helium flex lines*, and a *cold head* (expansion device).

Dewar:

The Dewar is a stainless steel, vacuum-jacketed container built for the purpose of storing liquid helium with minimal boil off. The Dewar is sealed from the atmosphere so that only helium gas can enter it. The *cold head* liquefies the helium gas inside the Dewar.

Extraction Line:

Liquid helium is extracted from the *Dewar* through the extraction line. The extraction line is a vacuum-jacketed, flexible stainless steel hose. A vacuum jacketed, manually operated valve is attached to the top of the extraction line. Liquid helium is withdrawn from the *Dewar* by opening the valve. The positive pressure inside the *Dewar* pushes the liquid helium out of the *Dewar*.

Helium Compressor Module:

Located inside the *helium compressor package*, the helium compressor module is an oil-lubricated compressor that compresses low-pressure helium to the necessary high pressure.

Helium Compressor Package:

The helium compressor package houses the *helium compressor module* and all other components that cool and purify helium and provide system safety control. The helium compressor package compresses the low-pressure helium returning from the *cold head* and provides clean, high-pressure helium to the *cold head*.

Helium Flex Lines:

The helium flex lines are corrugated, stainless steel hoses that transport helium between the *helium compressor package* and the *cold head*.

Helium Inlet Manifold:

The helium inlet manifold is mounted on the inlet of the *Dewar* and consists of a quick connect fitting, a pressure regulator, a pressure transducer for the *Dewar pressure controller*, and a pump-out valve. It provides a connection for and regulates the flow of helium into the *Dewar* and allows evacuation of the Dewar with a vacuum pump.

Liquid Level Monitor and Pressure Controller:

The LM-510 liquid level monitor and pressure controller reads the *Dewar* liquid level and pressure, as well as maintaining the Dewar pressure above a set point using a heater. It communicates with the *touch screen computer* to control the system.

Pollution Degree 2:

Pollution degree 2 refers to the extent to which the local environmental conditions could affect the electrical safety of the system. See EN 61010 or UL 61010A for further details.

Pulse Tube Cryorefrigerator:

A pulse tube cryorefrigerator is a *cryorefrigerator* in which the *cold head* expands the helium using a pulse tube instead of a displacer or piston.

System:

The term "system" is used as a synonym for the Liquid Helium Plant. It consists of a *Dewar* with an attached *cold head*, a *helium compressor package*, a set of *helium flex lines*, a *touch screen computer*, a *liquid level monitor*, a *Dewar pressure controller*, and a *cold head temperature monitor*.

Touch Screen Computer:

The touch screen computer controls and monitors the operation of the liquid helium plant. It interfaces with the *helium compressor package*, *liquid level monitor*, *Dewar pressure controller*, and *cold head temperature monitor* to obtain information on the state of the system. It controls the system by transmitting commands to the *helium compressor package*, *liquid level monitor* and *pressure controller*.

1.3.2 Acronyms

The following acronyms are used in the text and provided here for convenient lookup:

FPT	Female Pipe Thread
GPM	Gallons per Minute
He	Helium
LHe	Liquid Helium
LHeP	Liquid Helium Plant
LPM	Liters per Minute
MPT	Male Pipe Thread
PSIG	Pounds per Square Inch Gauge

Section 2

Warranty

Section 2: Warranty

2.1 Statement of warranty

The *Cryomech LHeP* consists of a cryorefrigerator, dewar assembly, and various supporting assemblies, most of which are not manufactured by Cryomech, Inc. Due to the complexity of these parts, Cryomech supports all other manufacturers' standard warranties. If problems occur with these components after the manufacturers warranty expires, Cryomech will provide any support necessary to bring the entire plant back to optimum working condition. Provided that the customer installs, operates, and maintains this liquid helium plant according to the specifications and procedures set forth in this manual, Cryomech, Inc. extends a warranty on:

Cryorefrigerator: A (3) year warranty period or 12,000 operating hours, whichever comes first, is provided for the following components: all non-user serviceable components and workmanship of the helium compressor package, the cold head, and the helium flex lines. Note: This warranty does not cover user-serviceable parts.

Dewar Assembly: A (1) year warranty period is provided for these components. This includes the extraction line, the helium gas intake assembly, the helium gas safety relief assembly, and the dewar. The dewar is warranted to be free from defects in materials and workmanship which result in vacuum failure.

Level Sensor: A (1) year warranty period is provided for this component. This warrants it to be free from defects in materials and workmanship.

Temperature Diode Sensor: A (1) year warranty period is provided for this component.

Liquefaction Rate: Since the gaseous helium supply for the Liquid Helium Plant is the responsibility of the end user, Cryomech, Inc. does not warranty the liquefaction rate produced by the system. Please contact Cryomech to discuss the gaseous helium requirement to ensure optimum operation.

Cryomech, Inc. will supply maintenance and service support to address any problems that might occur during to operation of the plant. If found to be defective and in accordance with the terms of the limited warranty, Cryomech will provide replacement parts at no cost to the customer. However, all shipping and handling charges associated with any warranty repair are the responsibility of the customer.

2.2 Conditions that can void warranty

- *Operation of the liquid helium plant in any situation that does not meet the specifications in this section will void the warranty.* If you plan to operate the system outside any of the specified conditions, contact Cryomech. **See Section 5.**
- *Failure to follow the installation guidelines in this manual could result in voiding the warranty.* **See Section 6.**

- **DO NOT** lift the liquid helium plant or dewar by the eyebolt that is attached to the cold head. Doing so will damage the cold head. *This type of damage will void the warranty. See Sections 4, 5, and 7.*
- Failure to evacuate and charge the dewar will contaminate the condensing surfaces and decrease the liquid helium production. *The warranty does not cover this type of damage. See Sections 6 and 8.*
- The helium supply to the dewar must have a purity of **99.99%** helium or greater. Helium purities less than **99.99%** will contaminate the condensing surfaces and decrease the production of liquid helium. *The warranty does not cover this type of damage. See Sections 6 and 8.*
- Cooling water must meet the requirements in **Section 5**. *If water that does not meet the cooling water specifications in Section 5 is introduced into the system, even for cleaning purposes, it will void the warranty. See Section 6.*
- A voltage deviation of more than **10%** above or below the voltage rating can cause compressor motor overheating and possible failure. *Indications of operation outside that voltage range will void the compressor warranty. See Sections 6 and 7.*
- The cold head contains no user-serviceable parts. *Attempting to disassemble the cold head will void the warranty.* Contact Cryomech if the cold head needs to be returned for servicing. **See Section 8.**
- When adding helium to the compressor, the helium must be **99.999%** pure. Contamination by other gases will result in the freezing of the contaminant gases in the cold head because their freezing temperature is much higher than that of helium. Contaminants in the helium charge will severely degrade the function of cold head, and will require factory servicing. *Contamination of the helium by other gases is a common cause of premature failure and, unless resulting from a system failure, is not covered by the warranty. See Section 8.*
- Do not allow the lines to come into contact with corrosives or any type of commercial cleaning agent. *Helium leaks caused by exposure to corrosives or commercial cleaning agents will not be covered under warranty. See Section 6.*
- Never wet any part of the system. *Water getting into the system will void the warranty. See Section 8.*

Section 3







Safety

Section 3: Safety

3.1 Safety and information symbols





3.1.1 Equipment symbols

The safety and information symbol stickers placed on Cryomech, Inc. Liquid Helium Plants as well as Cryorefrigerators are defined below.

	Alternating current. The symbol signifies that alternating current is present.
	Internal ground. This symbol represents an internal protective grounding terminal. Such a terminal must be connected to earth ground prior to making any other connections to the equipment.
	Warning Icon. Refer to the documents that accompany the equipment.
	The CE icon is placed on a product if the product has been tested for and meets the safety standards set by the European Community. CE stands for Conformité Européenne.
	Power switch. This symbol designates an in/out or push/push switch.
	Read the manual or handbook sign. When this symbol is found on a piece of equipment, the user should read the whole manual before installation or use. This symbol is found on the compressor package.

3.1.2 Icons in the manual

Definitions of Warning, Caution, and Information icons in the manual:

	Warning Icon. A warning message is used when failure to observe instructions or precautions could result in injury or death to humans.
	Electrical Warning Icon. An electrical warning message is used when failure to observe instructions or precautions could result in electrical shock or burns to humans.
	Caution Icon. A caution message is used when failure to observe instructions or precautions could result in significant damage to equipment and/or facilities.
	Information Icon. The accompanying message contains information to aid the operator in obtaining the best performance from the equipment or other important information that does not involve danger to equipment or humans.

3.2 Warnings and cautions

Warnings and cautions for the Cryomech Liquid Helium Plants are listed here by subsystem. The same warnings and cautions appear in the appropriate places in the unpacking, installation, operation, and routine maintenance sections of this document.

3.2.1 Section 4: Inspection and Unpacking

Section 4.2.2 Specific directions for moving when unpacking



CAUTION

DO NOT lift the liquid helium plant or Dewar with the eyebolt that is attached to the cold head. Doing so will damage the cold head. *This type of damage will void the warranty.*

3.2.2 Section 5: Specifications

Section 5.2 Technical specifications



CAUTION

Operation of the liquid helium plant in any situation that does not meet the specifications in this section will void the warranty. If you plan to operate the system outside any of the specified conditions, contact Cryomech.

Section 5.5 Description of the liquid level monitor and pressure controller



CAUTION

DO NOT change settings of the liquid level monitor and pressure controller. Doing so may cause the automatic control system to malfunction.

Section 5.6 Description of the Dewar



CAUTION

DO NOT lift the liquid helium plant or Dewar with the eyebolt that is attached to the cold head. Doing so will damage the cold head. *This type of damage will void the warranty.*

3.2.3 Section 6: Installation

Section 6.1 Introduction



CAUTION

Failure to follow these installation guidelines could result in voiding the warranty.



WARNING

Personnel, including rescue workers, should not enter areas where the oxygen concentration is below 19.5% unless provided with a self contained breathing apparatus or air-line respirator.

Section 6.2 System Installation



WARNING

The liquid helium plant must be positioned to provide easy access to the circuit breaker mounted on the front panel of the compressor.

Section 6.2.1 Connect the helium supply to the Dewar



CAUTION

Failure to evacuate and charge the Dewar will contaminate condensing surfaces and decrease liquid helium production. *The warranty does not cover this type of damage.*



CAUTION

The helium supply to the Dewar must have a purity of 99.9% or greater. Helium purities less than 99.9% will contaminate the condensing surfaces and decrease the production of liquid helium. *The warranty does not cover this type of damage.*

Section 6.2.2 Connect the water lines to the helium compressor package



CAUTION

Cooling water must meet the requirements in Section 5. If water that does not meet the cooling water specifications in Section 5 is introduced into the system, even for cleaning purposes, it will void the warranty.

Section 6.2.3 Connect the helium compressor package to the main power

**CAUTION**

A voltage deviation of **more than 10%** above or below the voltage rating can cause compressor motor overheating and possible failure. *Indications of operation outside that voltage range will void the compressor warranty.*

**WARNING**

Be sure to follow all local electrical codes and guidelines.

**WARNING**

One lead of the helium compressor package is grounded. Never bypass this ground or attach the helium compressor package to an ungrounded circuit. A dangerous electrical hazard will develop.

3.2.4 Section 7: Operation

Section 7.1.1 Checks before operating

**CAUTION**

A voltage deviation of more than 10% above or below the voltage rating can cause compressor motor overheating and possible failure. *Indications of voltage operation outside that range will void the compressor warranty.*

Section 7.2.9 Dewar pressure

**CAUTION**

A Dewar pressure greater than 15 PSIG indicates a problem with the Dewar safety relief valves. The problem must be diagnosed and corrected immediately to prevent damage.

Section 7.5 Extraction of liquid helium

**WARNING**

Before extracting liquid helium from the Dewar, carefully read the following safety precautions. Improper handling of liquid helium may result in serious injury or death.

**WARNING**

If an excessive volume of liquid helium spills in a confined space, open all windows and doors to adequately ventilate the area. Helium can quickly displace atmospheric oxygen, resulting in dangerously low levels of oxygen for breathing. *At low oxygen concentrations, unconsciousness and death may occur in seconds without warning.*

Section 7.5.2 Insertion of the extraction line



WARNING

The operator should be outfitted with the recommended personal protective equipment outlined above before inserting the extraction line into the Dewar.

Section 7.5.3 Withdrawal of liquid helium



WARNING

The operator should be outfitted with the recommended personal protective equipment outlined in **Section 7.5, page 7-14**, before extracting liquid helium.



CAUTION

Damage to the valve stem and seat will occur if the valve is over-tightened.

3.2.5 Section 8: Routine maintenance

Section 8.3 Cold head



CAUTION

The cold head contains no user-serviceable parts. *Attempting to disassemble the cold head will void the warranty.*

CONTACT CRYOMECH TO RETURN THE COLD HEAD FOR SERVICING.

Section 8.4 Replace the adsorber



CAUTION

At no time should the Aeroquip® couplings be removed from the adsorber. Replacement can be completed without relieving system pressure, since the adsorber is equipped with Aeroquip® couplings for sealed removal.

**WARNING**

The input power must be disconnected from the helium compressor package before removing any helium compressor package panels.

Section 8.5 Vent excess helium from the compressor**CAUTION**

Venting more than 5 PSIG (.34 bar) of helium per minute will lead to improper oil migration within the system. If this condition occurs, factory service will be required.

Section 8.6 Recharge helium to the compressor**CAUTION**

When adding helium to the compressor, the helium must be 99.999% pure. Contamination by other gases will result in the freezing of the contaminant gases in the cold head because their freezing temperature is much higher than that of helium. Contaminants in the helium charge will severely degrade the cold head's function and it will require factory servicing.

Contamination of the helium by other gases is a common cause of premature failure and, unless resulting from a system failure, is not covered by the warranty.

**CAUTION**

No more than 5 PSIG (.34 bar) of gas should be added per minute to prevent internal oil contamination to the system. If such contamination occurs, factory service will be required.

Section 8.7 Dewar evacuation and charging**CAUTION**

Failure to evacuate and charge the Dewar will contaminate the condensing surfaces and decrease the liquid helium production. *The warranty does not cover this type of damage.*

**CAUTION**

The helium supply to the Dewar must have a purity of 99.9% or greater. Helium purities less than 99.9% will contaminate the condensing surfaces and decrease the production of liquid helium. *The warranty does not cover this type of damage.*

Section 8.8.1 Compressor package, cold head, and Dewar**CAUTION**

Never wet any part of the system. *Water getting into the system will void the warranty.*

Section 8.8.2 Aeroquip® couplings**WARNING**

Never remove an Aeroquip® coupling from the helium flex lines, cold head, adsorber or compressor without first relieving the helium charge. The pressure in any of the components can blow off the coupling with sufficient force to cause injury.

Section 4

Inspection and Unpacking

4 Section 4: Inspection and Unpacking

4.1 Inspection of crate



IMPORTANT

IF THERE IS ANY VISIBLE DAMAGE CONTACT CRYOMECH IMMEDIATELY; DO NOT OPEN OR TAMPER WITH THE PACKING CRATE.

Be sure to note on the shipping documents any visible damage to the crate, including tip indicators that have been activated.

4.2 Unpacking

The system is packaged in a secure packing crate. The base of the packing crate is a wooden pallet, to which the system is strapped. The walls of the crate are placed around the system, attached to the pallet, and to each other, with tension clips (Klimp® fasteners). After adding packing material, the top is clipped onto the packing crate.

4.2.1 Directions for unpacking:

1. After ensuring no visible damage to the packaging, remove the top of the packing crate by unfastening the Klimp® fasteners that join the top to the sides.
2. Check for tip indicators on the inside of the packing crate and notify Cryomech if interior tip indicators have been activated, even though tip indicators on the outside were not.
3. Check for any visible signs of damage besides activated tip indicators.
4. Locate and remove items that can easily be lifted out of the crate.
5. Remove the sides of the packing crate by unfastening the Klimp® fasteners that join the sides to the pallet.
6. Remove packing material and any straps that anchor items to the pallet.
7. Ensure that adequate space is prepared for the equipment (see **Section 6** for installation directions).
8. If possible, retain the packing materials and crate for use in the future, to ship the equipment to Cryomech.

4.2.2 Specific directions for moving when unpacking

1. The liquid helium plant needs to be lifted off the pallet base and onto the floor with a fork truck or crane/hoist. The liquid helium plant cart is fitted with lifting channels to aid in lifting the system. The plant **should not be tipped more than 5°** at any time. **See Section 5** for diagram schematics and weight specifications.

**CAUTION**

DO NOT lift the liquid helium plant or dewar with the eyebolt that is attached to the cold head. Doing so will damage the cold head. *This type of damage will void the warranty.*

2. The liquid helium plant cart is equipped with castors and can be rolled by hand after it's removed from the crate.

4.3 Inspection of equipment

4.3.1 Packing list

There is a packing list included with the system. Check that all parts listed on the packing list are included in the crates. Then, check for any signs of damage to the parts.

4.4 Returning a system to Cryomech

1. Contact Cryomech for a return of material authorization, **RMA** number, and for additional detailed instructions on how to properly return system components.
2. Repackage the system:

**IMPORTANT**

Use the original crate and packaging materials to minimize the likelihood of damage during shipping.

- Place the Liquid Helium Plant on the pallet on top of sufficient vibration dampening material to prevent the wheels from touching the pallet.
 - Strap the plant to the pallet, making certain that there is sufficient protective material between the plant and the straps in order to protect the paint.
3. Be sure to include shipping labels on the crate showing which side is up and making clear that the shipment is fragile.
 4. Cryomech highly recommends using "tip and tell" indicators. These indicators are helpful in determining whether your package was handled properly or not. Replace used "tip and tell" indicators with new ones (total of three per crate).
 5. When the shipment is ready, please contact Cryomech for further instructions on shipping.

Section 5

Specifications

Section 5: Specifications

5.1 Intended use of equipment

The liquid helium plant is used to produce and store liquid helium.

5.2 Technical specifications



CAUTION

Operation of the liquid helium plant in any situation that does not meet the specifications in this section will void the warranty. If you plan to operate the system outside any of the specified conditions, contact Cryomech.

5.2.1 Weights and dimensions

Parameter	Value	
System Weight:		
Dewar Empty	1020 lb	463 kg
Dewar Full	1061 lb	481 kg
Dimensions (L x W x H)	53.5 x 30.5 x 72 in	136 x 77.5 x 183 cm
Dewar Capacity	40 gal	150 liters

5.2.2 Cooling water specifications

Parameter	Value	
Cooling Water: minimum flow @ maximum temperature	See Figure 5-1	
Maximum Inlet Pressure	110 PSIG	7.6 bar
Alkalinity	5.8 < pH < 8.0	5.8 < pH < 8.0
Calcium Carbonate	Concentration < 80 PPM	Concentration < 80 PPM

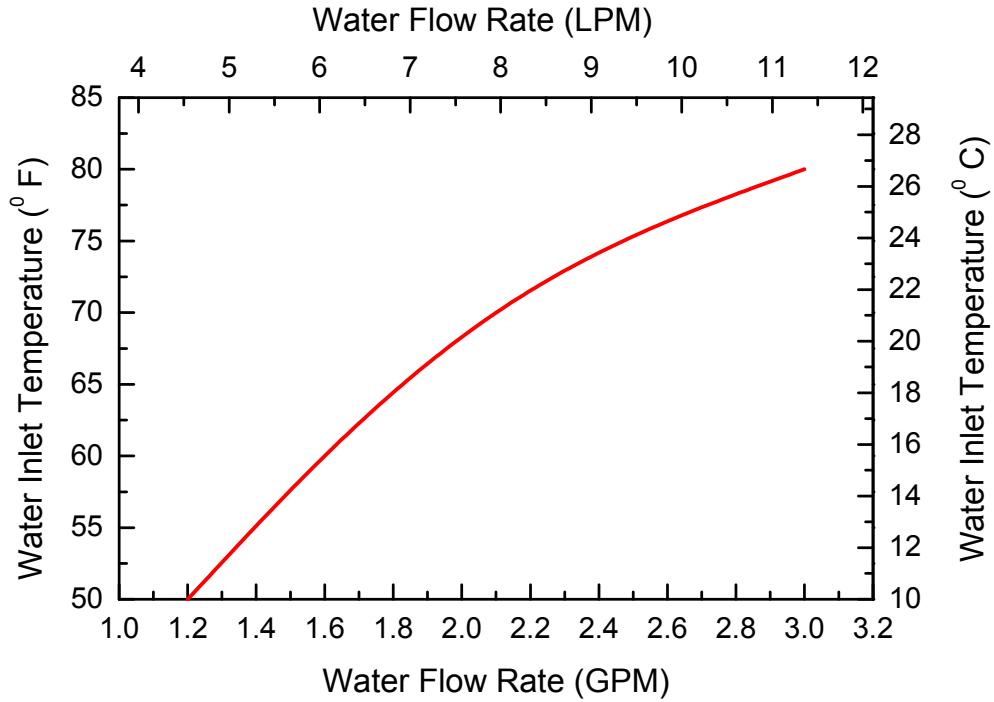

Figure 5-1: Cooling water requirement*

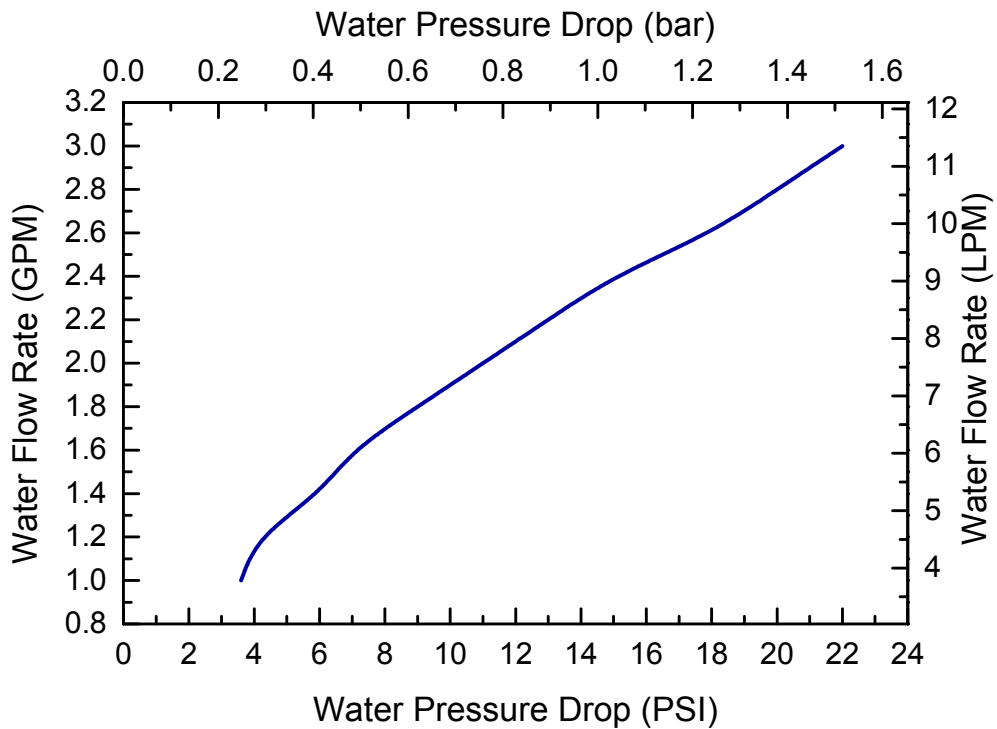

Figure 5-2: Cooling water pressure drop*

* When using a 50-50% mixture of ethylene glycol and water increase the flow rate 10%. Pressure drop values will increase 40%.

5.2.3 Electrical specifications

Parameter	200/230 Volt 60 Hz Model	440/480 Volt 60 Hz Model	200 Volt 50 Hz Model	380/415 Volt 50 Hz Model
Nominal voltage	200/230 VAC	440/480 VAC	200 VAC	380/415 VAC
Operating voltage range	180 - 253 VAC	396 - 528 VAC	180 - 220 VAC	342 - 456 VAC
Frequency	60 Hz	60 Hz	50 Hz	50 Hz
Phase	3	3	3	3
Nominal Input Power	12.3 kW	12.3 kW	11.6 kW	10.8 kW
Maximum: Steady state:	10.0 kW	9.9 kW	8.9 kW	9.0 kW
Maximum current	41 A	18.5 A	38.5 A	19 A
Dedicated circuit breaker	50 A	25 A	50 A	25 A
Mains supply voltage fluctuations	Up to ± 10% of the nominal voltage	Up to ± 10% of the nominal voltage	Up to ± 10% of the nominal voltage	Up to ± 10% of the nominal voltage

5.2.4 Operating parameters

Parameter	Value	
Ambient temperature range*	45 to 100°F	7 to 38°C
System helium pressure	230 ± 5 PSIG @ 60 Hz (15.86 ± .34 bar @ 60 Hz)	17.93 ± .34 bar @ 50 Hz (260 ± 5 PSIG @ 50 Hz)
Acceptable location	Indoors only	Indoors only
Maximum altitude for use	6560 Ft	2000 m
Environment	Pollution Degree 2	Pollution Degree 2
Installation	Category II	Category II
Maximum relative humidity	80% for T < 88°F Decreasing linearly to 50% at 104°F.	80% for T < 31°C Decreasing linearly to 50% at 40°C.
Maximum sound level	76 dBA at 1 meter	76 dBA at 1 meter

*The helium compressor package is designed to operate in an ambient temperature range from **45°F to 100°F (7 to 38°C)**. If the temperature is **below 45°F**, increased viscosity of the oil could prevent start-up and/or cause poor lubrication. Operation **above 100°F** will cause overheating and subsequent problems. If a unit must be subjected to either extreme, consult Cryomech, Inc.

5.2.5 Safety devices

A number of safety switches and valves are located inside the compressor package and on the cold head. They operate automatically, to protect the compressor package and cold head from developing extreme conditions that can cause damage. Most of them are totally transparent to the user and are monitored by the compressor control panel - see **Section 7** for further detail. The safety devices listed below are not monitored by the compressor control panel.

High-Pressure Relief Valve

The compressor package high-pressure relief valve is set at **420 ± 5 PSIG (29 ± .34 bar)**. At pressures **above 420 PSIG (29 bar)**, the relief valve will open automatically and relieve pressure to the atmosphere.

Internal Motor Overload Switch

A motor overload switch, located inside the compressor module, protects the system by sensing excessive current draw and temperature. This switch automatically resets itself after the compressor module cools to an acceptable level.

Cold Head High Pressure Relief Valve

The cold head high-pressure relief valve is set at **425 ± 5 PSIG (29.3 ± .34 bar)**. At pressures **above 425 PSIG (29.3 bar)**, the valve will open automatically and relieve pressure to the atmosphere.

5.3 Description of the LHeP

The liquid helium plant is completely assembled and securely mounted on a cart. The cart, fitted with wheels, allows the user to easily move the plant as needed.

Quick connect couplings are used on the helium supply to the dewar and the cooling water lines to the compressor. The quick connect couplings allow the user to easily disconnect the system and move it to another location to dispense liquid helium. The major components are labeled and discussed in further detail in the following section.

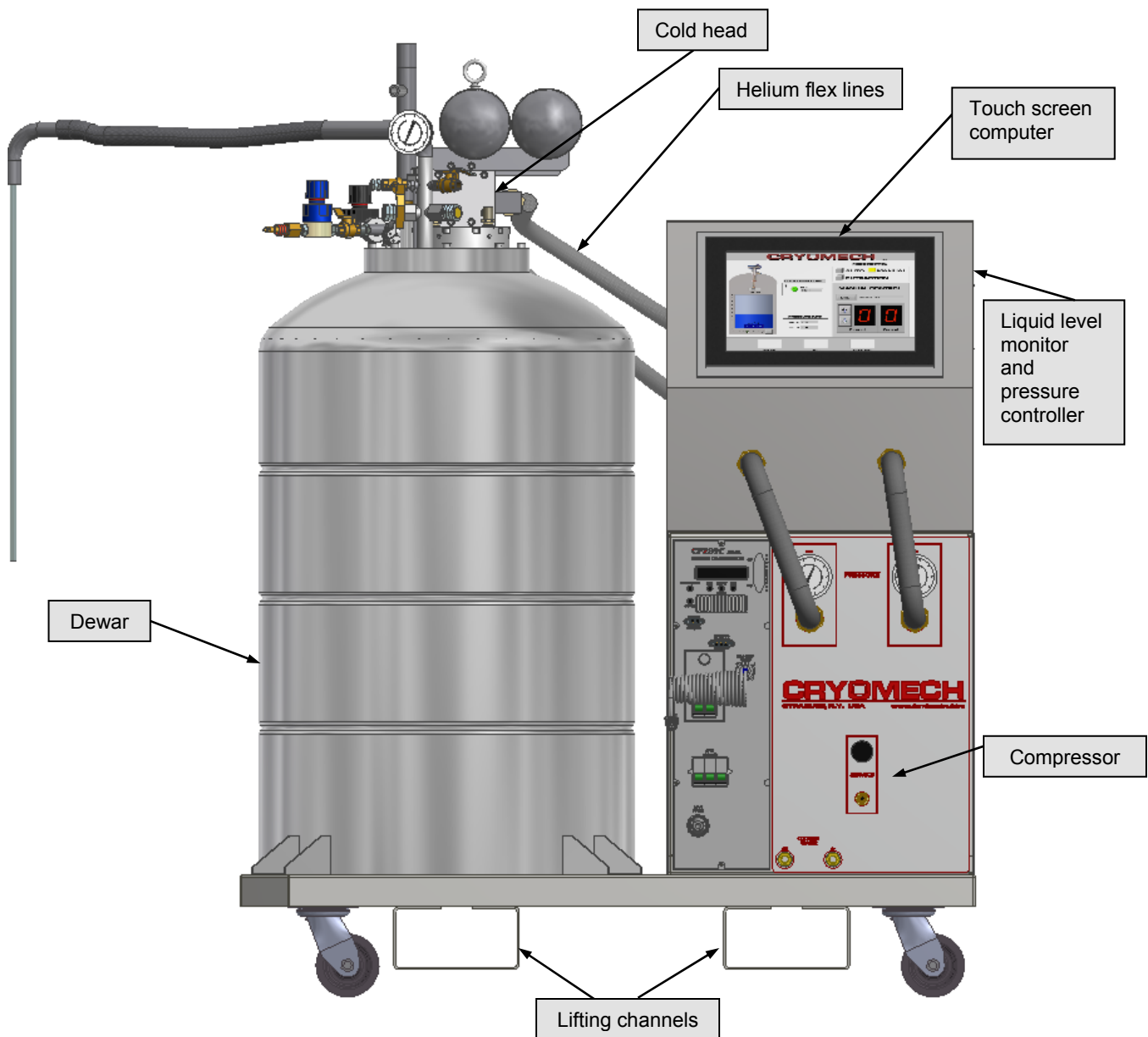

Figure 5-3: Front view of the liquid helium plant

5.4 Description of the compressor

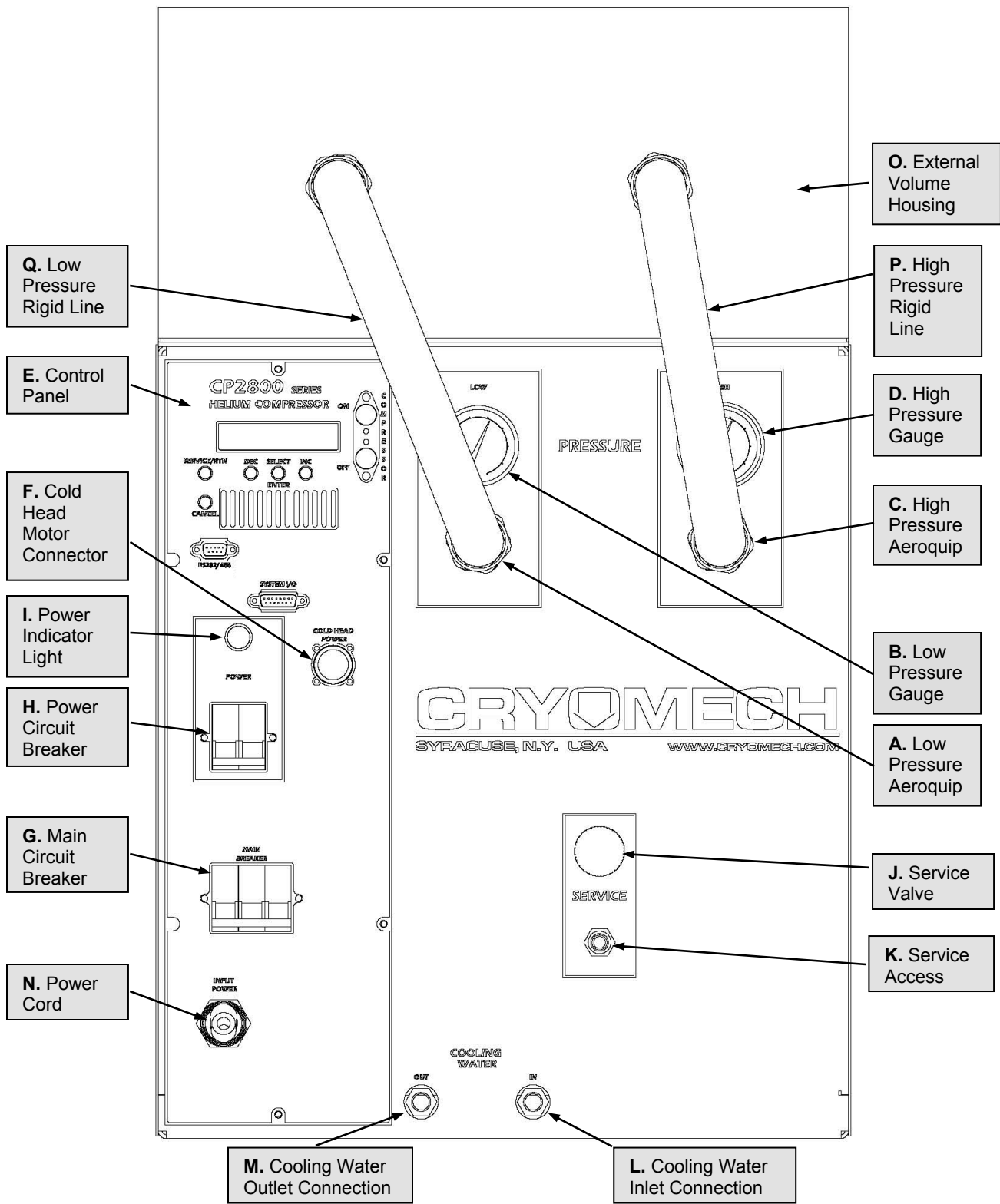

Figure 5-4: Front panel of the compressor package

5.4.1 Front panel interfaces

This section describes the function of all operator interfaces on the front panel of the CP2800 Series Compressor Package, including switches and valves. It also describes the functions of all connectors, electrical cords and gauges on the front panel.

A. Low-Pressure Aeroquip®

The low-pressure rigid line attaches to the low-pressure Aeroquip® that returns helium gas from the cold head to the compressor package.

B. Low-Pressure Gauge

The low pressure gauge displays the pressure of the helium gas that is being returned to the compressor package. When the compressor package is off and the *complete system is at room temperature*, the gauge should read the pressure specified in **Section 5.2**.

C. High-Pressure Aeroquip®

The high-pressure rigid line attaches to the high-pressure Aeroquip® that supplies compressed helium gas from the compressor package to the cold head.

D. High-Pressure Gauge

The high-pressure gauge displays the pressure of the compressed helium gas that is transported from the compressor package. When the compressor package is off and the *complete system is at room temperature, including the cold head*, the gauge should read the pressure specified in **Section 5.2**.

E. Control Panel

The control panel houses the manual compressor controls and system display.

F. Cold Head Motor Connector

The cold head motor cord attaches to the cold head motor connector to provide power from the compressor package to the cold head motor or remote motor assembly.

G. Main Circuit Breaker

The main circuit breaker provides over-current protection for the cryorefrigerator and also functions as a main power disconnect.

H. Power Circuit Breaker

The power circuit breaker protects the control panel circuitry and also functions as a power disconnect for the control panel.

I. Power Indicator Light

The power indicator light illuminates when the power circuit breaker is switched to the on position.

J. Service Valve

The service valve is the valve used to regulate the amount of helium being added to or released from the system.

K. Service Access

The service access is used in conjunction with the service valve for adding helium to or releasing helium from the system.

L. Cooling Water Inlet Connection

The cooling water inlet connection provides water to the compressor package from your facility to cool the compressor package during operation. A quick connect coupling is attached to the compressor inlet port. The mating quick connect coupling is supplied with the system. The mating coupling thread size is a 3/8 FPT (3/8" Female National Pipe Thread).

The water must meet the specifications provided in the Cooling Water Specifications table in **Section 5.2**.

M. Cooling Water Outlet Connection

The cooling water outlet connection carries heated water away from the compressor package after the water has been heated by cooling the compressor package during operation. A quick connect coupling is attached to the compressor outlet port. The mating quick connect coupling is supplied with the system. The mating coupling thread size is a 3/8 FPT (3/8" Female National Pipe Thread).

N. Power Cord

The power cord supplies power from the wall to the entire system.

O. External Volume Housing

The external volume housing contains the high and low pressure external volumes. The high and low pressure helium flex lines are connected to the male Aeroquip® connectors located on the top of the housing. The high and low pressure rigid lines are connected to the male Aeroquip® connectors located on the front face of the housing.

P. High Pressure Rigid Line

The high pressure rigid line carries the high pressure helium supply from the compressor to the high pressure external volume.

Q. Low Pressure Rigid Line

The low pressure rigid line carries the low pressure helium return from the low pressure external volume to the compressor.

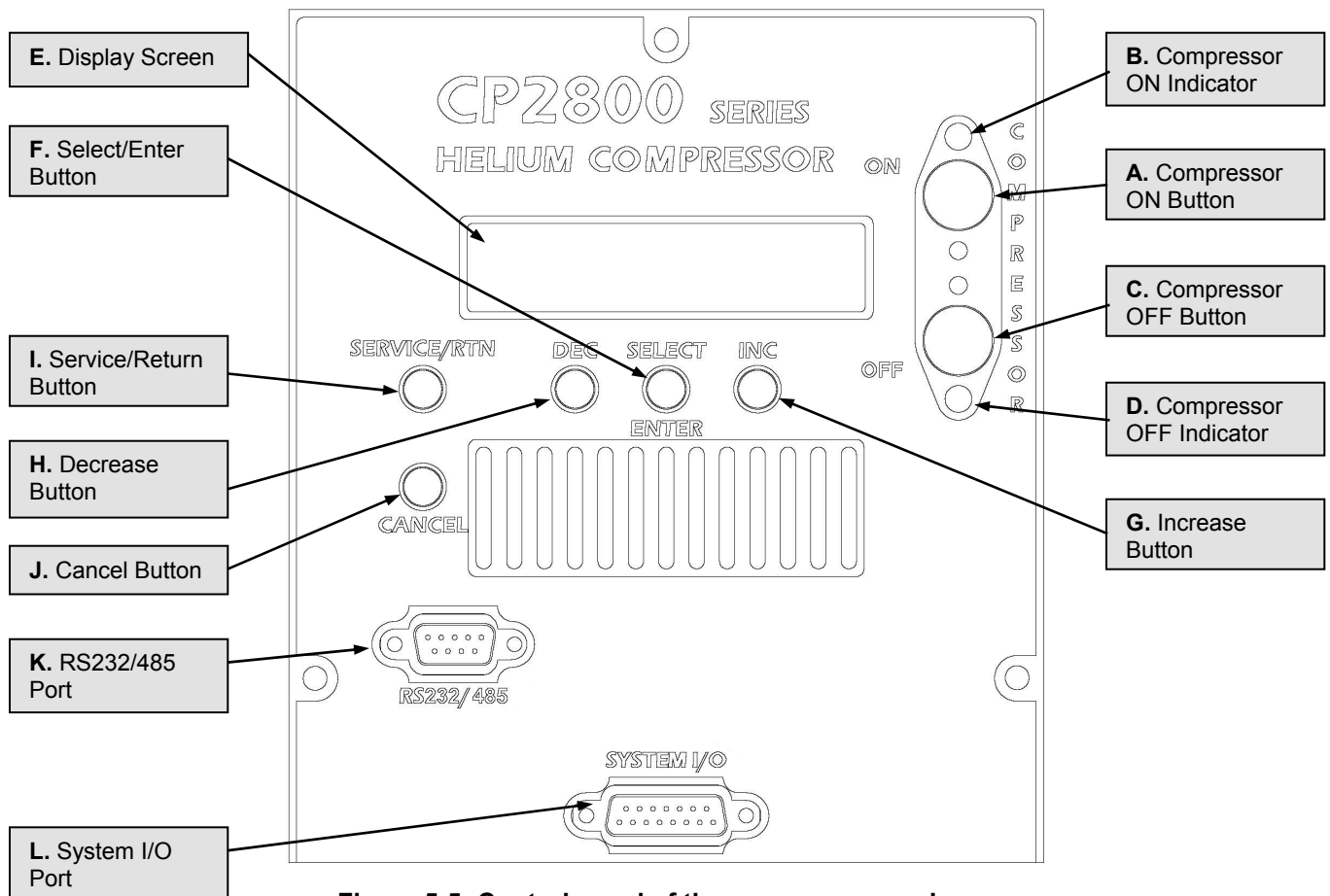

Figure 5-5: Control panel of the compressor package

5.4.2 Control panel description

A. Compressor ON Button

The **Compressor ON** button should **NOT** be used to manually start the system. The touch screen computer program controls the operation of the system and will override this function. Manually starting the compressor may cause a severe malfunction of the program. Refer to **Section 7** for operation instructions.

B. Compressor ON Indicator Light

The Compressor **ON** indicator light is illuminated when the compressor is operating.

C. Compressor OFF Button

The **Compressor OFF** button should **NOT** be used to manually stop the system. The touch screen computer program controls the operation of the system and will override this function. Manually stopping the compressor may cause a malfunction of the program. Refer to **Section 7** for operation instructions.

D. Compressor OFF Indicator Light

The compressor **OFF** indicator light is illuminated when the compressor is switched off by the compressor **OFF** button, or when one of the compressor internal safety switches has tripped.

E. Display Screen

The display screen (also known as the run time screen) displays system status, warnings, error messages, and the various menus available.

F. Select/Enter Button

The **Select/Enter** button is used to navigate down each menu, and to enter changes in values.

G. INC (Increase) Button

The **INC** button is used to navigate back and forth along the top level of the menu.

H. DEC (Decrease) Button

The **DEC** button is used to navigate back and forth along the top level of the menu.

I. Service/Return Button

The **Service/Return** button is used to switch from the run time display to the top level of the menu (Monitor Sensors/Error Log/Event Log/User Settings/Service).

J. Cancel Button

The **Cancel** button is used to navigate back through the menu options.

K. RS232/485 Port

The **RS232/485** port communicates with the touch screen computer to monitor and control the system.

L. System I/O Port

The **System I/O** port is a DB15 female socket that is used in special applications.

5.5 Description of the liquid level monitor and pressure controller

**CAUTION**

DO NOT change settings of the liquid level monitor and pressure controller. Doing so may cause the automatic control system to malfunction.

The liquid level monitor and pressure controller is used to monitor the liquid helium level and pressure in the Dewar, as well as utilize a heater to maintain the Dewar pressure above a set point.

Refer to the *Operating Instruction Manual for the Model LM-510 Liquid Cryogen Level Monitor* for information about this instrument.

5.6 Description of the dewar

The dewar is a stainless steel, vacuum jacketed container built for the purpose of storing liquid helium with minimal boil off. The dewar is sealed from the atmosphere, so that only helium flowing from the helium gas supply can enter it.



Figure 5-9: LHeP dewar

A dewar flange is bolted to the top of the dewar and is sealed to the dewar with an O-ring. Attached to the dewar flange are the cold head, the helium gas inlet regulator, the liquid level monitor receptacle, the vapor pressure receptacle, the temperature diode receptacle, the pressure relief valves, the vent valve, the evacuation valve, and the extraction line. **See Figures 5-10 and 5-11.**

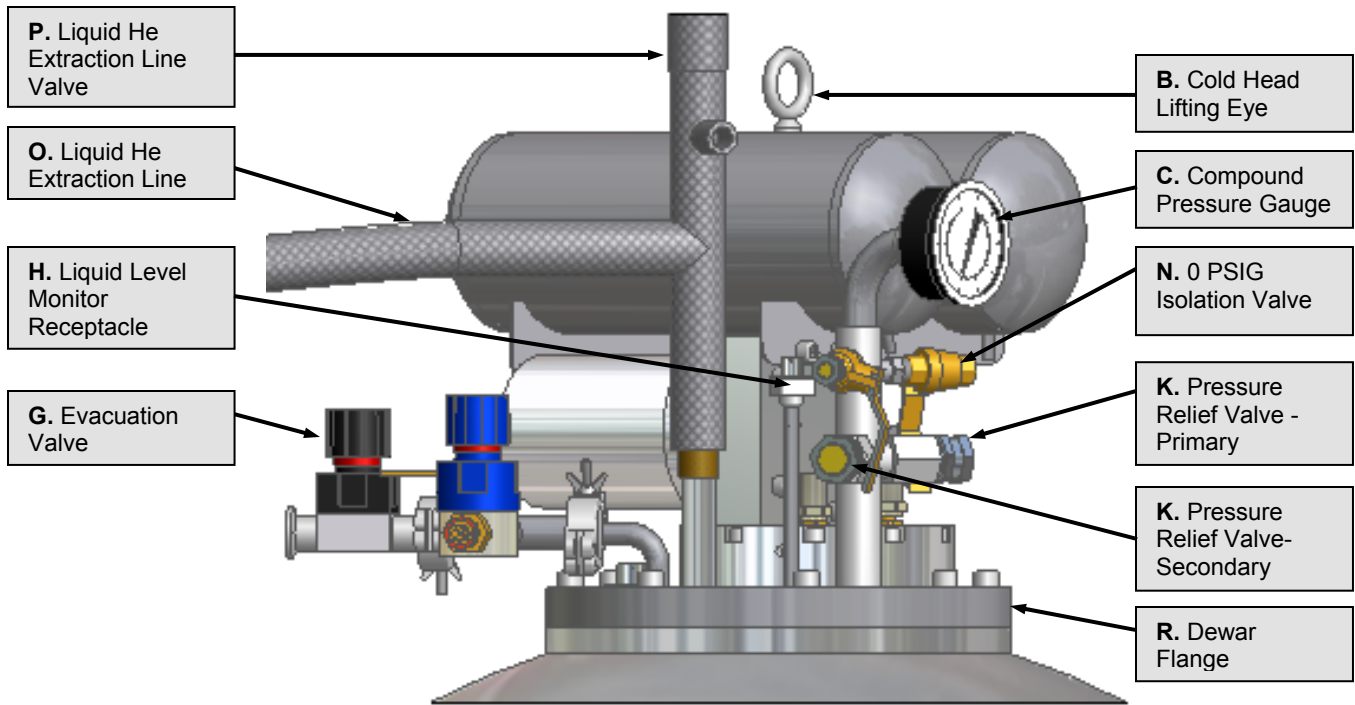

Figure 5-10: Detailed view of the top of the dewar

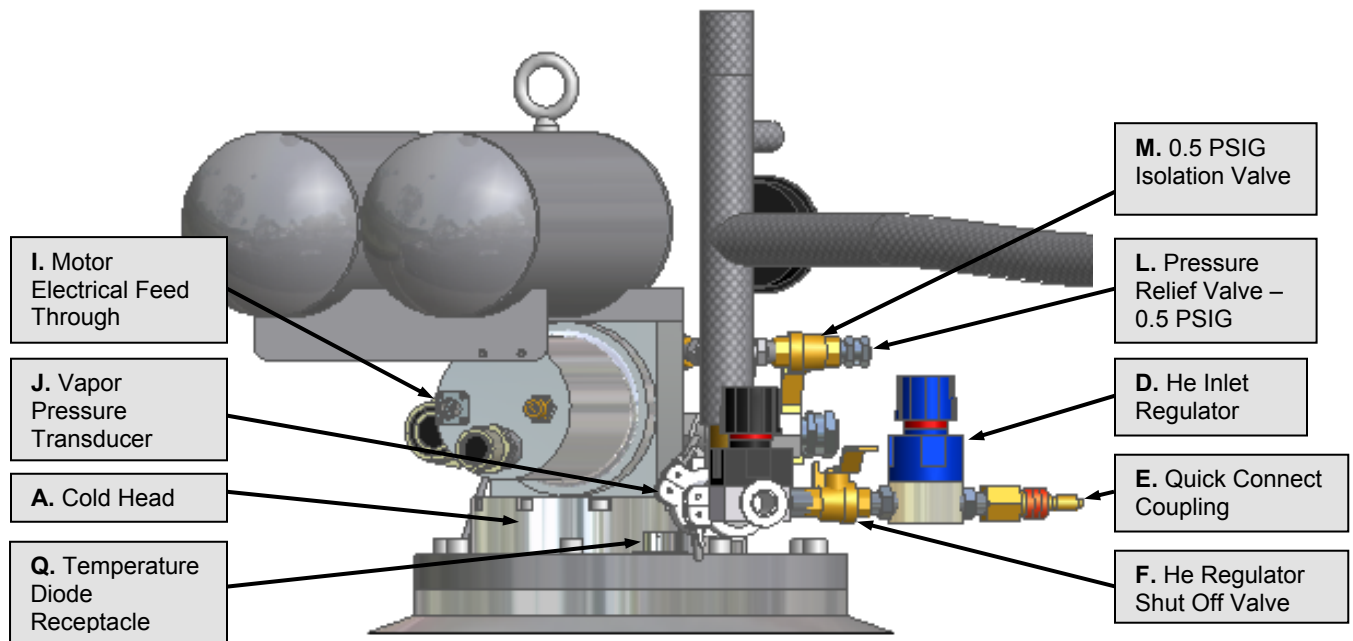

Figure 5-11: Alternate detailed view of the top of the dewar

A. Cold Head

The cold head is bolted to the top of the dewar. An O-ring, located between the Dewar Flange and the cold head, seals the helium gas inside the dewar.

B. Cold Head Lifting Eye

The lifting eye is designed to lift the cold head and the dewar flange only. It is not designed to lift the entire liquid helium plant or dewar.

**CAUTION**

DO NOT lift the liquid helium plant or dewar with the eyebolt that is attached to the cold head. Doing so will damage the cold head. *This type of damage will void the warranty.*

C. Compound Pressure Gauge

The compound pressure gauge, with a range of **30 in Hg** to **15 PSIG**, displays the gaseous helium pressure inside the dewar.

D. He Inlet Regulator

The He inlet regulator has been preset at the factory for an operating pressure of approximately **3 PSIG (0.2 bar)** inside the dewar.

E. Quick Connect Coupling

A quick connect coupling is attached to the inlet port of the He regulator for connection to the gaseous helium supply to the dewar. The mating quick connect coupling is supplied with the system.

F. He Regulator Shut Off Valve

The helium regulator shut off valve is attached to the outlet port of the He regulator. Closing the valve will stop the flow of gaseous helium into the dewar. The valve must be open during operation.

G. Evacuation Valve

The evacuation valve is fitted with a **KF16** flange for connection to a vacuum pump to evacuate the liquid storage space of the dewar.

H. Liquid Level Monitor Receptacle

The liquid level monitor receptacle is connected to the liquid level probe inside the dewar. The level monitor cable connects this receptacle to the liquid level monitor.

I. Motor Electrical Feed Through

The cold head motor cord attaches to the motor electrical feed through to supply the required power from the helium compressor package to the cold head motor.

J. Vapor Pressure Transducer

The vapor pressure transducer is wired to a connector on the back of the dewar pressure controller.

K. Pressure Relief Valves

The primary pressure relief valve will begin to open when the pressure inside the dewar is approximately **10 PSIG**. Two secondary **15 PSIG** pressure relief valves will activate if the primary relief valve fails to open.

L. Pressure Relief Valve – 0.5 PSIG

The **0.5 PSIG** pressure relief valve is attached to the outlet end of the isolation valve. Opening the isolation valve will maintain a pressure of **0.5 PSIG** (0.03 bar) in the dewar.

M. Isolation Valve (0.5 PSIG)

The isolation valve is a manually operated ball valve. It is normally closed for standard operation of the liquid helium plant. Opening this isolation valve will maintain the pressure in the dewar at **0.5 PSIG (0.03 bar)** by venting any excess helium to the atmosphere.

N. Isolation Valve (0 PSIG)

The isolation valve is a manually operated ball valve. It is normally closed for standard operation of the liquid helium plant. Opening this isolation valve will open the dewar to the atmosphere and vent all helium in the dewar.

O. Liquid He Extraction Line

The liquid He extraction line is used to withdraw liquid helium from the dewar. The extraction line and extraction valve are both vacuum jacketed to reduce boil off losses when transferring liquid.

P. Liquid He Extraction Line Valve

The liquid He extraction line valve is a vacuum jacketed bellows valve designed specifically for cryogens.

Q. Temperature Diode Receptacle

The temperature diode receptacle is connected to a silicon diode mounted to the cold head's helium condenser inside the dewar. The diode cable connects to this receptacle and the diode connector on the cold head temperature monitor.

Section 6

Installation

Section 6: Installation

6.1 Introduction

The entire section on the installation of the liquid helium plant should be reviewed before installing the system.



CAUTION

Failure to follow these installation guidelines could result in voiding the warranty.

If the system is installed in an enclosed, confined space, an oxygen monitor/alarm should be installed to protect against an elevated or deficient oxygen level. Helium is an asphyxiant in high concentrations.

If the liquid helium dewar ruptures or develops a leak, the liquid helium will quickly vaporize and may create dangerously low oxygen concentrations in the ambient air.

Further, if a leak develops in the helium gas supply line to the dewar, a dangerously low oxygen concentration in the ambient air is possible.

Being odorless, colorless, tasteless, and nonirritating, helium has no warning properties. Humans possess no senses that can detect the presence of helium. At low oxygen concentrations, unconsciousness and death may occur in seconds and without warning.



WARNING

Personnel, including rescue workers, should not enter areas where the oxygen concentration is **below 19.5%** unless provided with a self contained breathing apparatus or air-line respirator.

6.2 System installation

- Confirm that the physical space containing the liquid helium plant has an ambient temperature in the range of **45 to 100°F (7 to 38°C)**.
- Place the liquid helium plant in a level position. For the helium compressor package to operate under optimal conditions, it must be oriented **within 5°** of being level.



WARNING

The liquid helium plant must be positioned to provide easy access to the circuit breaker mounted on the front panel of the compressor.

- Position the system so there is sufficient space around it for attaching the gaseous helium supply to the helium inlet regulator and the water lines to the compressor. Consideration should also be given to the space required for the user to remove liquid helium from the dewar.
- Once in position, lock the wheels.

6.2.1 Connect helium supply to the dewar

The dewar is shipped with a positive pressure of helium gas inside. If the dewar compound pressure gauge reads **0 PSIG**, the dewar must be evacuated and charged with helium before use. **See Section 8** for the evacuation and charging instructions.



CAUTION

Failure to evacuate and charge the dewar will contaminate condensing surfaces and decrease liquid helium production. *The warranty does not cover this type of damage.*

The pressure regulator has been preset at the factory for an operating pressure of approximately **3 PSIG (0.2 bar)** when the dewar is at liquid helium temperature and a supply of helium is connected. When the dewar is at room temperature and during the early stages of cool down, the dewar pressure will be higher.



Figure 6-1: Helium inlet regulator

The inlet pressure regulator should not be adjusted. Adjusting the pressure regulator away from **3 PSIG (0.2 bar)** during normal operation may cause the control program to malfunction. Please contact Cryomech before adjusting the pressure regulator.



CAUTION

The helium supply to the dewar must have a purity of **99.99%** or greater. Helium purities less than **99.99%** will contaminate the condensing surfaces and decrease the production of liquid helium. *The warranty does not cover this type of damage.*

The helium inlet regulator attached to the dewar is fitted with a quick connect coupling for connection to the helium supply. The mating quick connect coupling supplied with the system must be attached to the helium supply line. The mating coupling thread size is a **3/8 MPT (3/8" Male National Pipe Thread)**.

Both ends of the quick-connect couplings are self-sealing. When disconnected, they will prevent the helium gas in the supply line and dewar from escaping.

The helium supply line should be made from a flexible material to allow for connecting and disconnecting the quick connect coupling. The supply line must be terminated with a **3/8 FPT** (3/8" Female National Pipe Thread) fitting.

1. Make sure that the helium supply is turned **OFF**.
2. Apply Teflon tape or pipe sealant to the **3/8 MPT** threads on the quick connect coupling.
3. Thread the quick connect coupling into the helium supply line fitting and tighten with a wrench.
4. Turn the helium supply **ON** and check for leaks.
5. Connect the helium supply line to the dewar regulator.
 - Push the supply line coupling onto the mating coupling on the helium inlet regulator.
 - A click will be audible when the couplings are locked together.

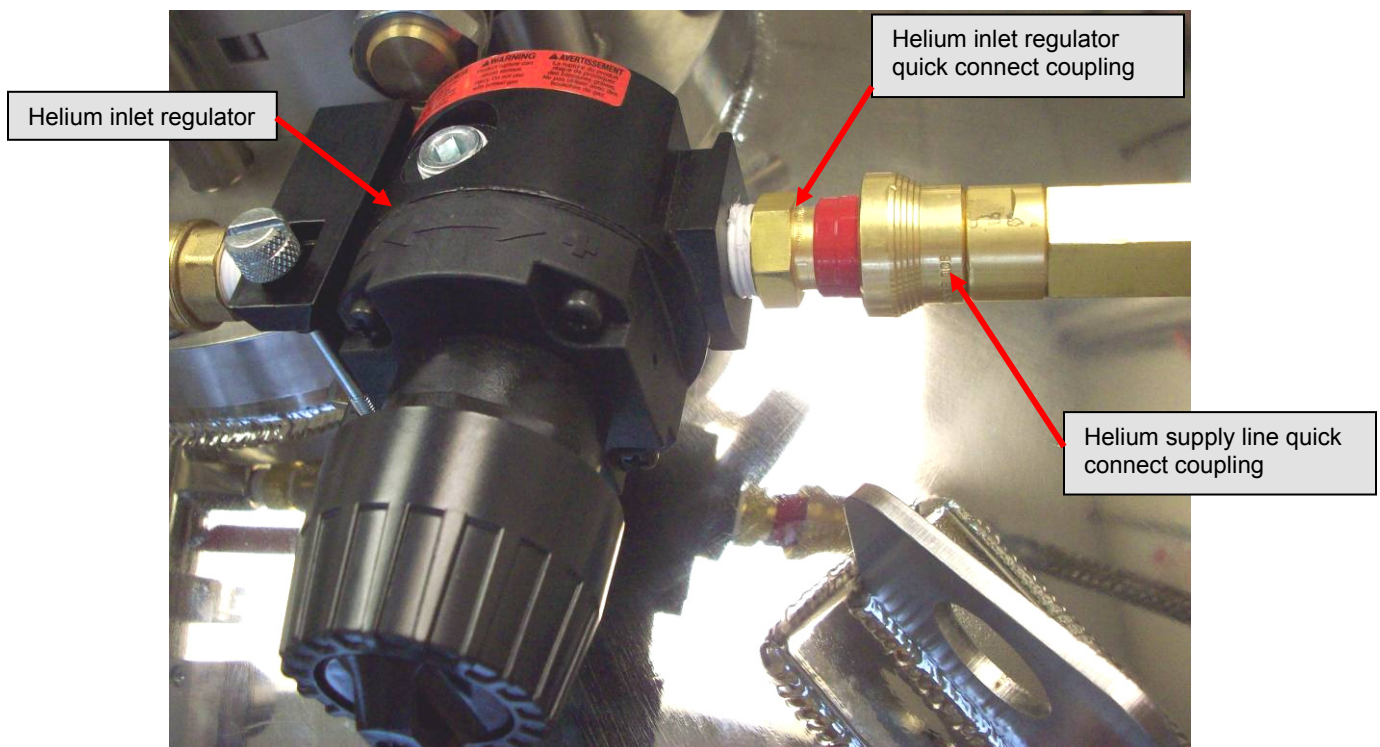

Figure 6-2: Connecting the helium supply line to the dewar

- To unlock the couplings, push the flared section of the female coupling towards the red collar on the male coupling.
- Once unlocked, the couplings can be separated.

6.2.2 Connect the water lines to the helium compressor package



CAUTION

Cooling water must meet the requirements in **Section 5**. *If water that does not meet the cooling water specifications in **Section 5** is introduced into the system, even for cleaning purposes, it will void the warranty.*

The inlet and outlet cooling water connections are fitted with quick connect couplings. The mating quick connect couplings supplied with the system must be attached to the water supply and drain lines. The mating coupling thread size is a **3/8 FPT** (3/8" Female National Pipe Thread).

Both ends of the quick-connect couplings are self-sealing. When disconnected, they will prevent water in the compressor, as well as the supply and drain lines, from escaping.

The supply and drain lines should be made from a flexible material to allow for connecting and disconnecting the quick connect coupling. The lines must be terminated with a **3/8 MPT** (3/8" Male National Pipe Thread) fitting.

1. Make sure that the cooling water supply is turned **OFF**.
2. Apply Teflon tape or pipe sealant to the threads on the **3/8 MPT** (3/8" Male National Pipe Thread) fittings on the ends of the supply and drain lines.
3. Thread the quick connect couplings onto the supply and drain lines and tighten with a wrench.
4. Connect the supply line to the *Cooling Water In* port and the drain line to the *Cooling Water Out* port.
 - a. Pull the collar on the female coupling back, slide the coupling onto the compressor's male coupling.
 - b. Release the collar and push the couplings together.
 - c. A click will be audible when the couplings are locked together.

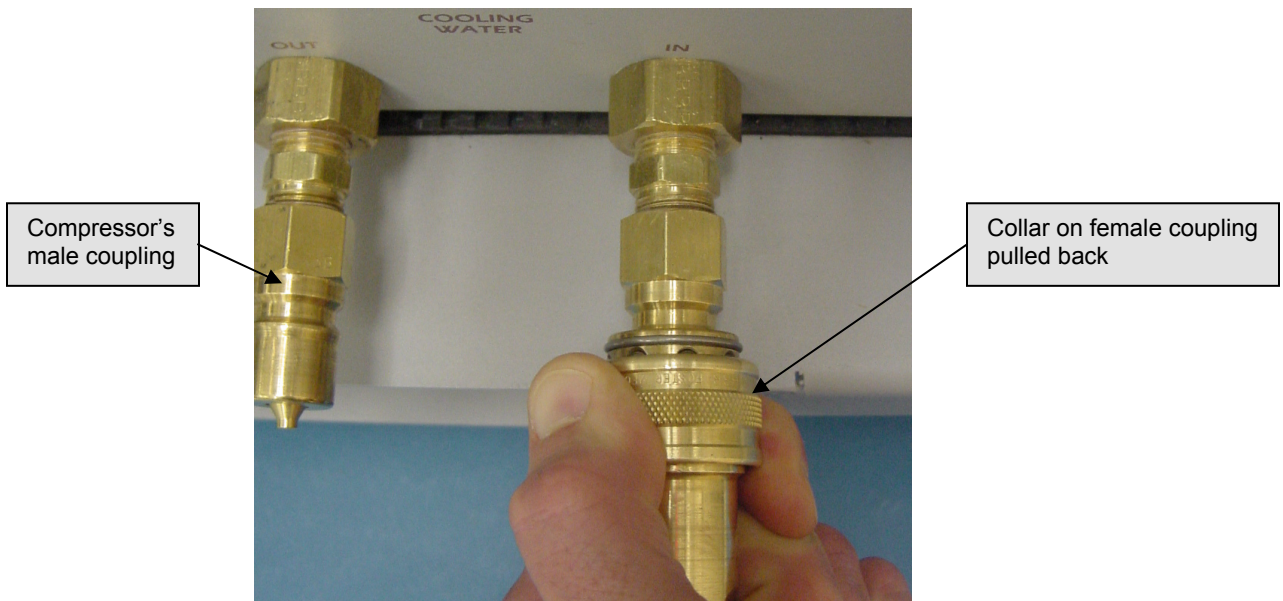

Figure 6-3: Connecting the water line couplings to the compressor package

5. Turn **ON** the cooling water supply and check for leaks.
6. Make certain the cooling water flow rate and inlet temperature meets the requirements in **Section 5**.
7. To disconnect the couplings, pull the collar back.

6.2.3 Connect the helium compressor package to the main power



CAUTION

A voltage deviation of **more than 10%** above or below the voltage rating can cause compressor motor overheating and possible failure. *Indications of operation outside that voltage range will void the compressor warranty.*

1. The liquid helium plant **MUST** be connected to a dedicated circuit breaker. The breaker must be mounted near the system, within easy reach of the operator, and must be marked as the disconnecting device for the system. Specifications for circuit breakers vary according to the system's operating voltage. See the electrical specification tables in **Section 5** for more information.
2. The helium compressor package comes with a main power cord attached. Assure that the length of the cord is sufficient to safely connect to the power source. If the cord is not sufficiently long, adjust the location of the liquid helium plant.



WARNING

Be sure to follow all local electrical codes and guidelines.

3. Make sure that the dedicated circuit breaker is turned **OFF**.
4. The ground (or earth) wire in the power cord is either green (60 Hz systems) or green/yellow stripe (50 Hz systems). Connect the ground wire in the power cord to the ground (or earth) connector in the breaker panel, making sure to tighten the wire into the connector securely. It is important not to disable this wire.
5. Connect the remaining hot wires in the power cord to the corresponding lugs on the dedicated breaker in the breaker panel, making sure to tighten the connector securely. The order of the wires is not important at this time - correct order will be determined in **Section 7**.



WARNING

One lead of the helium compressor package is grounded. Never bypass this ground or attach the helium compressor package to an ungrounded circuit. A dangerous electrical hazard will develop.

Section 7

Operation

Section 7: Operation

7.1 Starting the liquid helium plant

With the installation complete, make the following checks **before** starting the liquid helium plant. Automatic operation of the liquid helium plant is controlled by the touch screen computer. Carefully follow the steps outlined in this section to ensure proper startup and operation of the liquid helium plant.

7.1.1 Checks before operating

1. Input power meets the specifications found on corresponding identification labels.



CAUTION

A voltage deviation of more than 10% above or below the voltage rating can cause compressor motor overheating and possible failure. ***Indications of voltage operation outside the specified range will void the compressor warranty.***

2. The dedicated circuit breaker is switched **ON**.
3. The cooling water meets requirements of flow rate and temperature range, specified in **Section 5.2.2** of this manual.
4. The helium pressure is as follows:
 - a. Compressor package:
 - Gauges should read as specified in **Section 5.2.4** of this manual.
 - If the pressure is too high, refer to **Section 8.5** of this manual.
 - If the pressure is too low, refer to **Section 8.6** of this manual.
 - b. Dewar:
 - The gauge should **always** indicate a positive pressure.
 - If the Dewar is empty and the compound pressure gauge reads **0 PSIG**, refer to **Section 8.7** of this manual.

7.1.2 Startup procedure

1. Switch **ON** power to the compressor package at the **MAIN** circuit breaker.
2. Switch **ON** power to the compressor controls at the **POWER** circuit breaker.
 - a. Both the green **ON** light (above the circuit breaker) and the yellow compressor **OFF** light will illuminate.
 - b. A series of audible beeps will sound.
 - c. The front panel will initially display the compressor model number, date, and time.
 - After a few seconds, the top line will display **COMPRESSOR OFF**.

- d. The touch screen computer will automatically start up. This will take a few minutes.
 - The control software should start in **Auto Continuous** mode.
 - If the program is not already in Auto Continuous mode, press the **Auto Continuous** mode button on the touch screen monitor.
3. The green, **ON** light (above the Compressor **ON** button), will illuminate and the front panel will display **COMPRESSOR ON**.
4. If the compressor front panel display indicates **PWR PHASE ORDER BAD**, perform the following steps to correct the phase error in the compressor package:
 - a. Switch **OFF** both circuit breakers on the front panel of the compressor package.
 - b. Switch **OFF** the dedicated circuit breaker to disconnect the system from power at the source **to prevent electrical shock**.
 - c. Examine the power cord and wire colors at the panel circuit breaker.
 - Re-wire the compressor by switching **any 2** of the **3 input** power wires.
 - d. Switch **ON** the dedicated circuit breaker.
 - e. Perform **steps 1 – 4**, above.

7.2 Normal operation

7.2.1 Touch screen computer program overview

The touch screen computer program automatically controls the operation of the LHeP, displays all relevant system information, and allows for remote viewing and control of the system.

The computer is programmed to monitor and control the temperature, pressure, and liquid helium level (corresponding volume) of the LHeP Dewar through the following instruments: SCM 10, HRC 100, and the LM 500, respectively. It is also programmed to automatically turn the attached compressor and cold head **ON** or **OFF**, in order to save energy and increase efficiency of the system. When the **Runtime** tab is selected, the main screen displays pertinent system information in one convenient location. This is also where the compressor status, Dewar pressure control, warning messages, and a diagram of the Dewar can be found. **See Figure 7-1.**

Note: *When installed with the Cryomech (HRS) Helium Recovery System, the RSS (recovery system status) parameters will also be conveniently displayed on the runtime screen, in the upper, right-hand corner. See **Figure 7-2** and refer to the **HRS manual** for a more detailed description of these parameters.*

At the bottom of the screen are four tabs; each can be selected to navigate for various purposes: to change parameter set points, to access various functions, and to obtain other specific information. These tabs include: **Runtime**, **Logging**, **Graph**, and **System tools**.

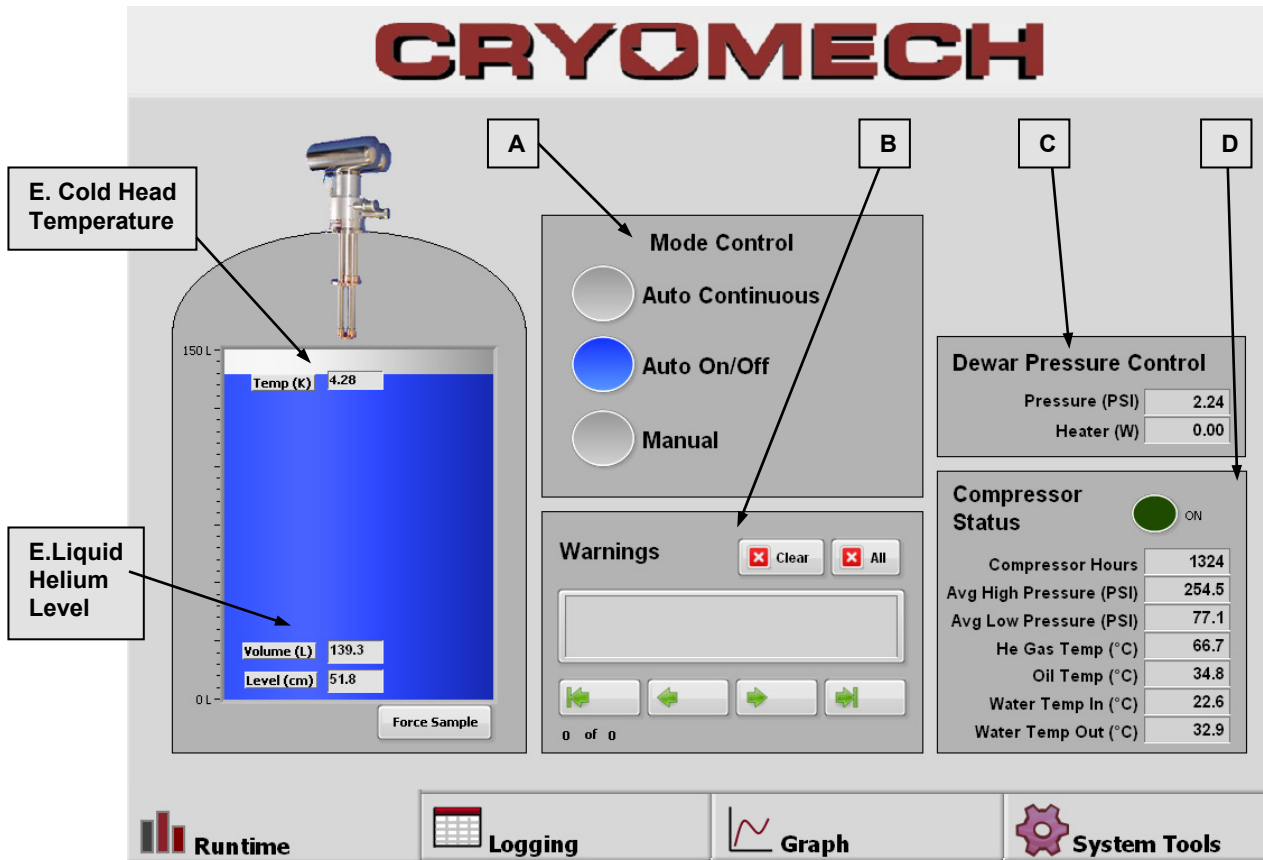

Figure 7-1: Touch screen computer program, runtime display

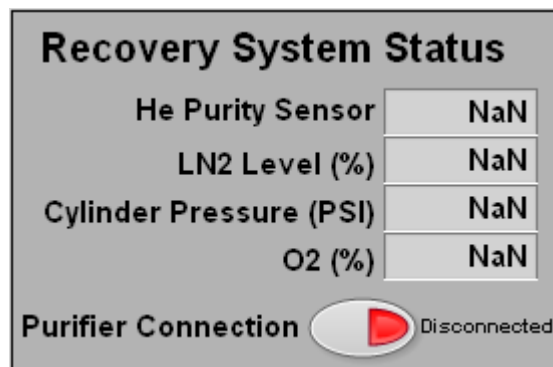

Figure 7-2: RSS Box (optional)

Runtime

A. Mode Control

The **Mode Control** box of the **Runtime** tab contains three modes of operation. Press the oval-shaped **button** directly to the left of the desired **mode**. Upon selection, the operating program will initiate, and the button will illuminate. For a more detailed description of the following operation modes, refer to the corresponding sections of this manual:

- **Auto continuous: Section 7.2.2**
- **Auto ON/OFF: Section 7.2.3**
- **Manual: Section 7.2.4**

B. Warnings

The **Warnings** box contains a text window listing the warning(s), a date, and a time which the message was initiated. Under normal operations, no warning messages should appear in this window. If warning messages do appear, the **arrow** buttons (located beneath the display window) allow for navigation through the messages, either one at a time or to the beginning and end messages. Further, above this window are **Clear** and **All** buttons, which will clear one or all message(s), respectively.

C. Dewar Pressure Control

The **Dewar Pressure Control** box displays the pressure, in **PSIG**, and the heater power, in Watts (**W**), specific to the most recent sensor readings within the Dewar.

D. Compressor Status

The **Compressor Status** box displays an **ON/OFF** switch as well as parameters related to the current status of the compressor. The **ON/OFF** switch will manually turn the compressor **ON** and **OFF**. The parameters which can be monitored in this box include: compressor hours, average high pressure (**PSIG**), average low pressure (**PSIG**), helium gas temperature (**°C**), Oil temperature (**°C**), water inlet temperature (**°C**), and water outlet temperature (**°C**).

E. Dewar Diagram

The **Dewar Diagram** visually displays the liquid helium level (**cm**), temperature (**Kelvin**), and volume (**Liters**) in the Dewar. The sample readings are automatically taken **every 30 minutes**. To take an instantaneous sample, press the **Force Sample** button in the bottom, right-hand side of the Dewar diagram.

Logging

The **System Log** records data every set-interval of time. See **Figure 7-3**. The **data log** options can be set in the system tools screen. See **Figure 7-5** and refer to the **System Tools** section below, **part B**. To take an instantaneous reading, press the **force log** button. To clear the screen, press the **clear** button. The screen will blank. However, the information is always saved in a text document. Please contact Cryomech, Inc. to retrieve the text file, system log history.

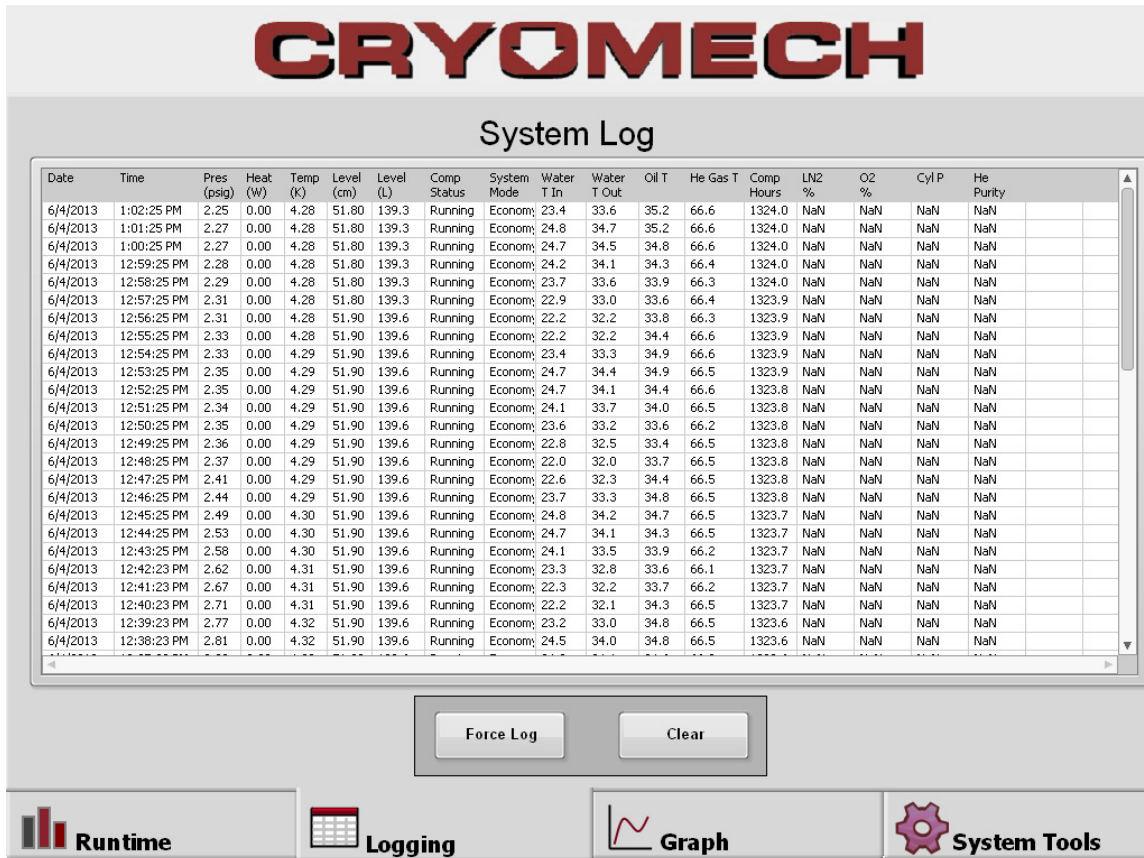

Figure 7-3: Logging screen

Graph

The **graph** screen features three different views with respect to the following time intervals: **day**, **week**, and **month**. This enables the user to collect and analyze liquid helium level data over time, providing valuable information regarding the system production and efficiency. **Figure 7-4** illustrates the week-view.

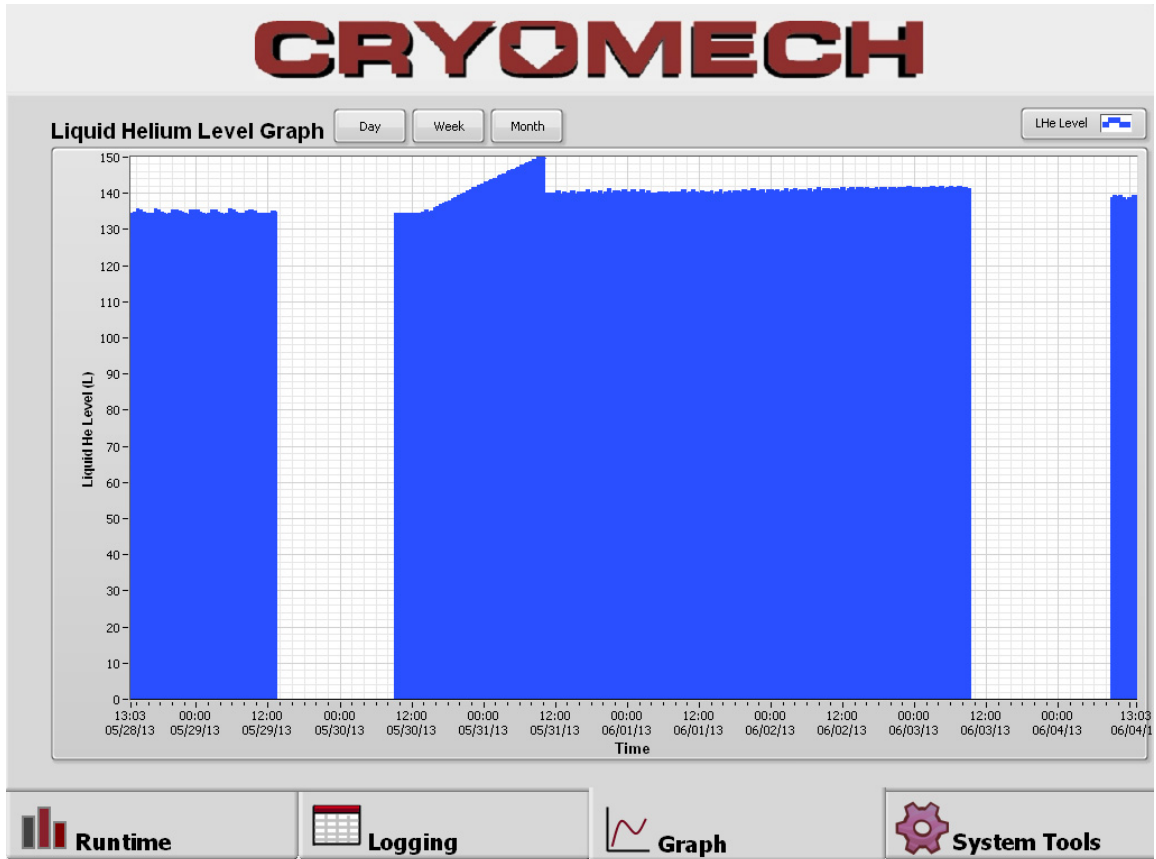

Figure 7-4: Graph screen, LHe level vs. Time

System Tools

The **system tools** screen displays the following options:

- A. Remote access
- B. Data log
- C. Configure security options
- D. Configure SCM10
- E. Save setup

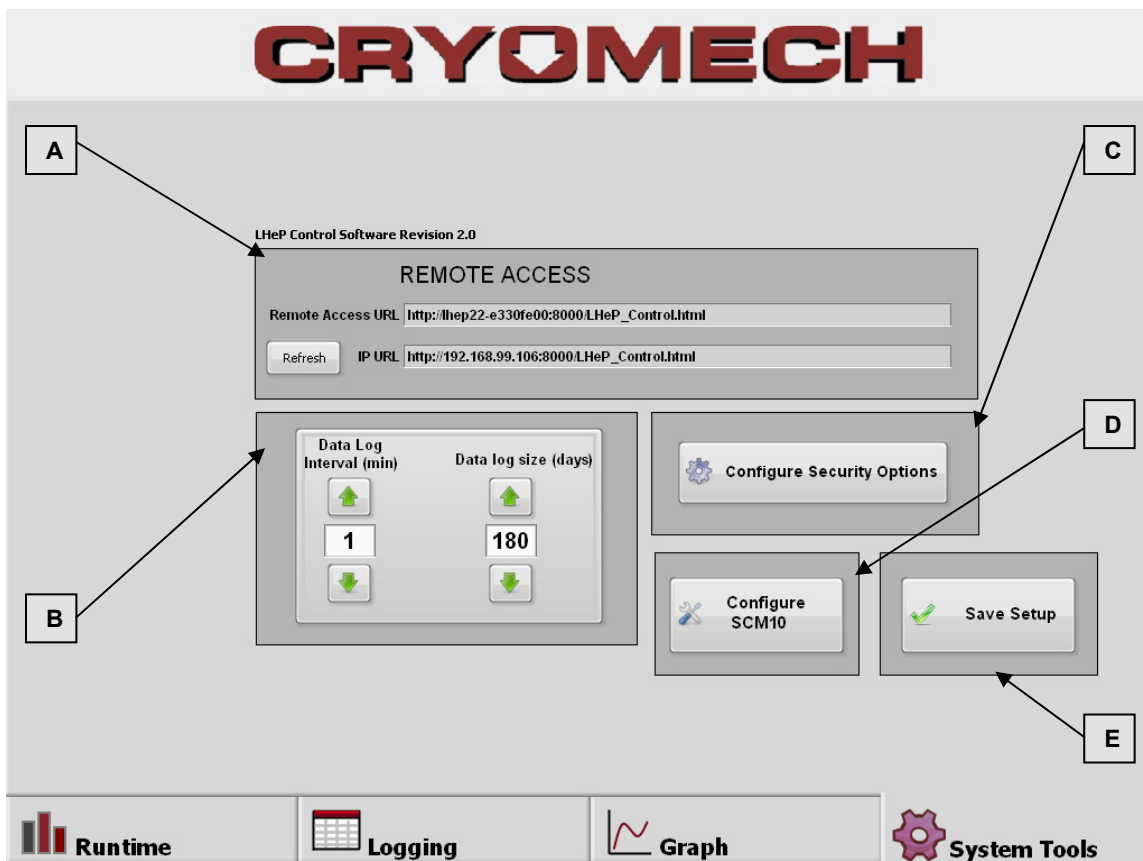

Figure 7-5: System tools screen

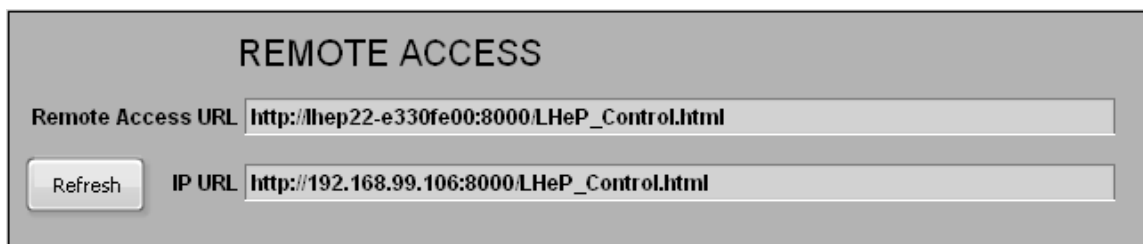

Figure 7-6: Remote Access Box

A. Remote access

To remotely control and monitor the **LHeP** system:

1. Plug in an Ethernet cable connected to the Local Area Network (LAN).
2. Select the **System tools** tab.
3. Select **refresh** in the remote access box. **See Figure 7-6.**
4. Record and type the **IP URL** into the internet browser of a networked computer.
 - a. A prompt to download and install the LabVIEW Runtime Engine may appear.
 - If not, search for and install the **LabVIEW 2011 Minimum Runtime Engine** from LabVIEW's website on the networked computer.
 - b. Once the Minimum Runtime engine is installed, enter the **IP URL** so the runtime screen will appear on the networked computer monitor.
 - c. The system can now be remotely monitored.
 - d. **Right click** on any grey area on the computer screen.
 - Several menu options will appear: request control of VI, release control of VI, show last message, show control time remaining, and close panel.
 - e. Select **request control of VI**.
 - The server touch screen will display **control transferred**. The ability to control the system at the touch screen is now disabled, and view-only mode is activated.
 - f. The system can now be remotely controlled.
5. Two options for relinquishing remote control of the **LHeP** system:
 - I. From the networked computer,
 - Right click, and select **release control of VI**.
 - The computer will display: **The connection with the server has been broken.**
 - II. From the server (touch screen).
 - Touch and hold the touch screen.
 - A menu will appear with the following options: regain control, switch control, and show last message.
 - Select the **switch control** option.

A message will appear: **server has control.**

Note: Selecting **regain control** will also switch control. However, this selection will activate the **lock control** function, which will lock out any further attempt to remotely control the system through the network. To unlock control, press and hold the screen and select **unlock control** from the menu. The **lock control/unlock control** feature disables and enables the ability to remotely access control and monitoring of the system.

B. Data log

Data Log **interval** (minutes) and **size** (days) can be changed in the data log box on the system tools screen. **See Figure 7-5.**

C. Configure security options

Select the **configure security options** button to activate the configure security options box to appear on the screen. See **Figure 7-7**.

- a. The default passcode is **1-1-1**. To set a new passcode, press the corresponding digit arrows **up** and **down** until the desired 3-digit combination is displayed.
- b. The **clear passcode** button will set the passcode display to **0-0-0**.
- c. The **lock on timeout** switch will lock the system server control once the set **timeout interval** (min) has elapsed.
 - Switch to **ON** and the system will lock after ten minutes. See **Figure 7-8**
 - Enter the 3-digit passcode in the **log in** box to unlock the system controls. See **Figure 7-9**.
- d. The **lock on user change** switch will disable the remote access option.
- e. Press **OK** to save any changes made within the configure security options box.
- f. Press **CANCEL** to exit the configure security options box without changing the current settings.
- g. The up and down arrows will change the **timeout interval** (c) in minutes.

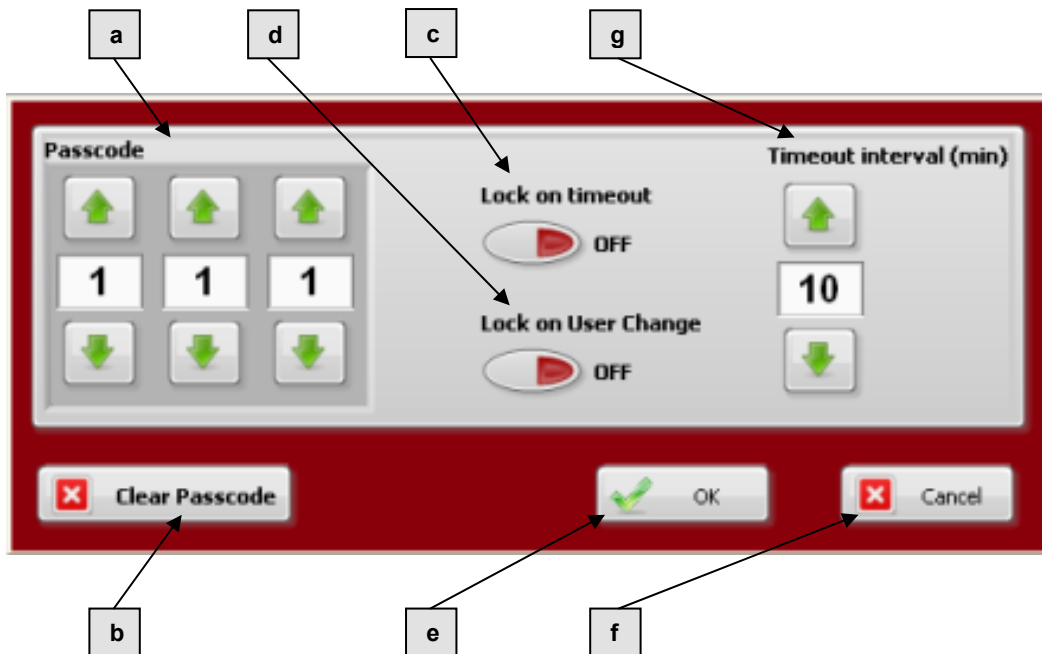

Figure 7-7: Configure security options box

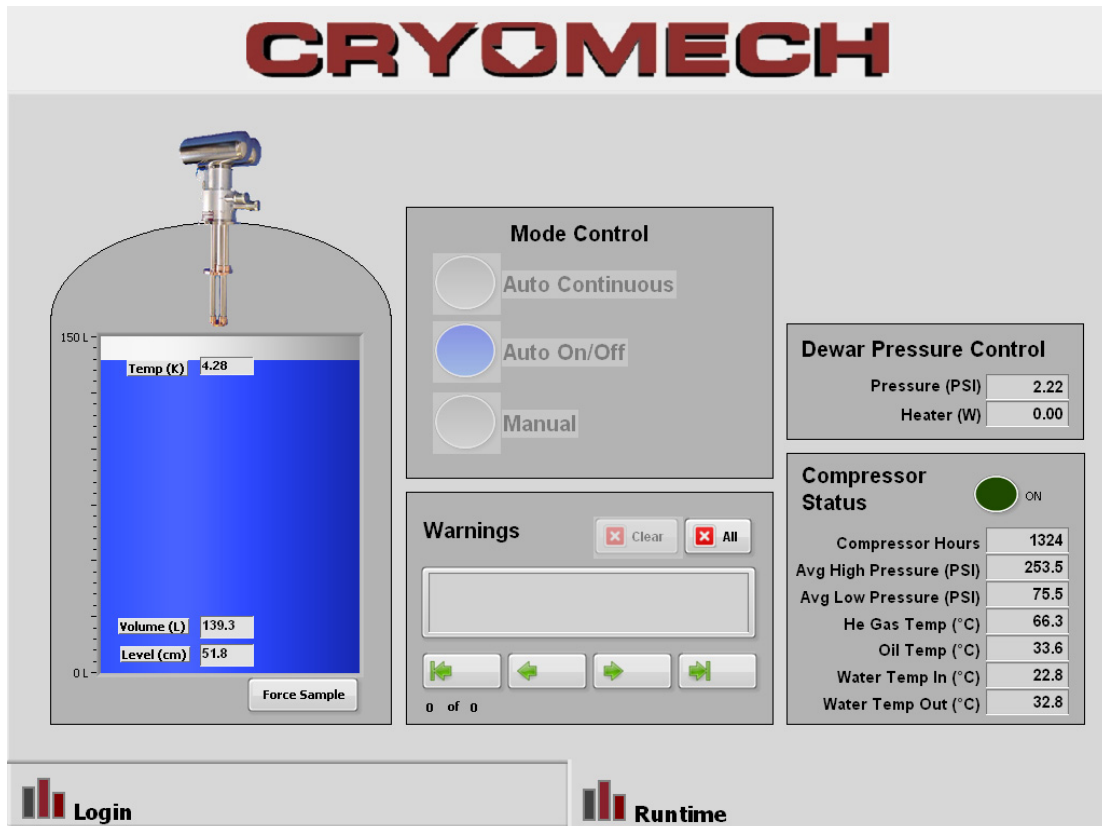

Figure 7-8: Locked runtime screen



Figure 7-9: Log in box

D. Configure SCM10

The **configure SCM 10** option in the system tools screen enables loading of a new calibration curve for the temperature sensor. If this function is required, please contact Cryomech, Inc. for further instructions.

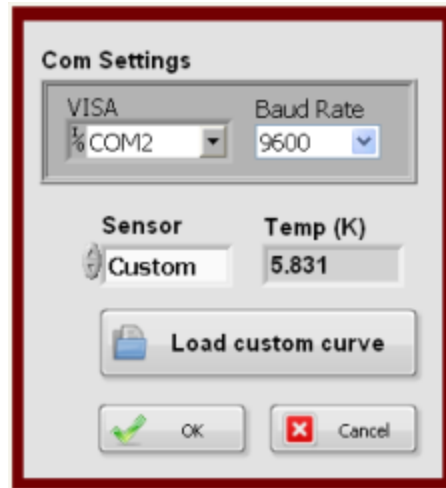

Figure 7-10: Configure SCM10 box

E. Save setup

The **save setup** button will permanently save any changes made in the system tools screen.

7.2.2 Auto Continuous Mode

Auto Continuous mode is the default operating mode when the system is turned **ON**. The compressor runs continuously in this mode; the main benefit is that the cold head maintains a low temperature to liquefy helium gas. If helium gas flow to the Dewar is stopped, the cold head will be ready to liquefy immediately as soon as flow is returned. If the Dewar is full and helium is extracted, the cold head will always be ready to liquefy helium gas. **Note:** *The auto continuous mode has lower energy efficiency than the auto ON/OFF mode; it may not be necessary to leave the compressor running continuously, for most applications.*

This mode functions by changing the Dewar pressure controller set point, depending on the conditions in the Dewar. When helium gas flow is shut off to the Dewar, the heater will automatically maintain pressure at approximately **0.75 PSIG**. When flow is returned to the Dewar, the pressure will rise and the heater will automatically turn off. This is to maintain a positive pressure in the Dewar at all times.

When the Dewar is full, the heater will turn on and raise the pressure to approximately **6.0 PSIG**. This prevents flow from passing through the pressure regulator on the inlet manifold. Once the liquid level in the Dewar falls **2cm** below full: the heater will turn off, the cold head will liquefy helium, the pressure will drop inside the Dewar, and helium gas will flow back into the Dewar through the pressure regulator.

7.2.3 Auto ON/OFF Mode

Auto **ON/OFF** operating mode cycles the compressor **ON** and **OFF** to conserve energy; the main benefit is that it saves electricity. The compressor will remain **OFF** approximately **60%** of the time. This mode functions by turning off the compressor and cold head when helium gas flow is shut off to the Dewar, and the pressure within is approximately **0.5 PSIG**. When the pressure reaches **8 PSIG**, the cold head will turn back on. This cycle will repeat **1-2 times** per hour, depending on the liquid helium level. When helium gas flow is returned to the Dewar, the cold head will automatically turn on within approximately **30 minutes**.

The cold head can be restarted manually:

1. Select the **Manual ON** mode.
2. Select the **Auto ON/OFF** mode.

The Compressor status indicator will illuminate; power is **ON**.

Note: *This mode should only be used with a Cryomech Helium Recovery System; it will result in helium boil off under certain conditions:*

When the Dewar is full, the cold head will turn **OFF** for **1 hour**. A small volume of liquid will boil off and return through the **10 PSIG** in-line relief valve to the atmospheric (recovery) bag. After 1 hour, the cold head will turn **ON**, reducing the pressure to **5 PSIG**. The cold head will turn **OFF** and the cycle will repeat. Once the liquid level in the Dewar drops **2cm** below full, the system will automatically start and run continuously until flow is turned off.

7.2.4 Manual mode

Manual **ON/OFF** mode is **NOT** recommended for permanent use; the computer program will not have any control, and the compressor will run continuously, regardless of the Dewar status and liquid helium level.

7.2.5 Compressor pressure

On start up, a pressure differential should be noticed immediately between the high and low pressure gauges. This differential will decrease as the cold head temperature decreases.

The typical pressure differential is approximately **220 to 250 PSI (15.2 to 17.2 bar)** with a range of **5 to 10 PSI (.34 to .7 bar)** on the pressure gauge needles.

7.2.6 Auditory indication

When operating properly, the cryorefrigerator will emit a rhythmic sound (squeak or chirp) approximately **80 times per minute**. This noise is an indication that there is proper flow of helium gas within the system.

7.2.7 Cold head temperature

Upon initial start up, the cold head condenser temperature (on the compressor display screen) will read approximately **300K**. Then, temperature will drop steadily for the first **4 to 6 hours** of operation. The cooling rate will slow when the temperature reaches approximately **100K**.

The temperature will continue to drop until the liquefaction point is reached; dependent on the pressure inside the Dewar:

- At **3 PSIG**, the display will indicate approximately **4.4K**.
- At **10 PSIG**, the display will indicate approximately **4.76K**.

When the system is producing liquid, and the Dewar pressure is stable, the condenser temperature will fluctuate **less than $\pm 0.1K$** .

When the helium gas supply to the Dewar drops below the liquefaction rate of the system, both the pressure inside the Dewar and the condenser temperature will decrease. If the temperature drops **below 3.9K**, the system will automatically shut **OFF**.

7.2.8 Cool down time

When the cold head condenser initially reaches the liquefaction temperature, liquid helium will drip off the condenser and collect in the bottom of the Dewar. Then, helium will evaporate upon contact with the Dewar, slowly cooling it to maintain a liquid helium temperature. The Dewar will take approximately **35 hours** to cool to **b**

7.2.9 Dewar pressure

Upon initial start up and cool down stages, the Dewar pressure will be greater than **3 PSIG**. As the Dewar cools to liquid helium temperature, the pressure in the Dewar will lower to approximately **3 PSIG**.

To prevent the Dewar from operating under vacuum, the LHeP incorporates a vapor pressure controller which heats the system, as necessary, to maintain pressure at the set pressure.

If the Dewar pressure gauge shows a pressure greater than **15 PSIG**, close the helium inlet valve and relieve the pressure through the **0.5 PSIG pressure relief valve** by opening the **isolation valve**.



CAUTION

A Dewar pressure greater than **15 PSIG** indicates a problem with the safety relief valves. The problem must be immediately diagnosed and corrected to prevent damage.

7.3 Warning display panel

Status and error messages will be shown on the Warnings section of the display screen. Possible status messages, error messages, and set points at which error conditions will occur are listed in **Section 7.9**.

7.4 Shutdown procedure

1. Press the **Manual** button.
2. Press the **OFF** button.
 - a. This will switch off the compressor system.
3. Switch **OFF** the circuit breakers mounted on the front-panel to shut down the entire system.

7.5 Extraction of liquid helium



WARNING

Before extracting liquid helium from the Dewar, carefully read the following safety precautions. Improper handling of liquid helium may result in serious injury or death.



WARNING

If an excessive volume of liquid helium spills in a confined space, open all windows and doors to adequately ventilate the area. Helium can quickly displace atmospheric oxygen, resulting in dangerously low levels of oxygen for breathing. *At low oxygen concentrations, unconsciousness and death may occur in seconds without warning.*

- *Transferring and handling liquid helium can be extremely hazardous if the proper precautions are not taken.* The hazards associated with liquid helium are: exposure to extremely cold temperatures, over pressurization of inadequately vented vessels due to the expansion of small amounts of liquid into large volumes of gas, and asphyxiation due to the displacement of oxygen in the air within confined areas.
- Liquid helium is a colorless, odorless, extremely cold liquid, **-452°F (-269°C)**, and can produce cryogenic burns of the skin, freezing underlying tissue almost instantaneously upon contact. **The recommended personal protective equipment for handling liquid helium includes a full face shield over safety glasses, loose-fitting thermal insulated or leather gloves, a long sleeve shirt, boots, and trousers without cuffs. Never tuck trousers inside the boots. Gloves should be loose fitting, so they can be quickly removed if liquid helium is spilled on or in them. Insulated gloves are not made to permit the hands to be put into liquid helium.** They will only provide short-term protection from accidental contact with liquid helium.
- Liquid helium vaporizes into large amounts of gas. **1 liter** of liquid helium will vaporize to **754 liters** of gas at room temperature, **68°F (20°C)**. When filling a vessel with liquid helium, make certain the vessel is adequately vented. If a sufficient amount of liquid helium is vaporized in a closed container, it will produce enormous pressures that could rupture the vessel. For this reason, *pressurized liquid helium vessels must be protected with multiple pressure relief devices.*
- The white colored vapor cloud observed when working with liquid helium is condensed moisture and extremely cold helium gas. When exposed to cold helium gas, delicate tissues such as those of the eyes can be damaged even when the contact is too brief to affect the skin of the hands and face.
- As liquid helium vaporizes, the resulting gas displaces the oxygen in the air. Since it is odorless, colorless, tasteless, and non-irritating, the undetectable gas can reduce the air's oxygen content below the level needed for safe breathing. Inhalation of helium in excessive amounts can cause dizziness, nausea, vomiting, loss of consciousness, and death. *At low oxygen concentrations, unconsciousness and death may occur in seconds without warning.* Thus, liquid helium must be stored and used only in a well-ventilated area. Oxygen monitors are recommended whenever liquid helium is handled in enclosed areas.

Liquid helium can be extracted from the Dewar at any time. The positive pressure inside the Dewar pushes the liquid helium out of the Dewar. Use the flexible, stainless steel extraction line to remove liquid helium from the Dewar. The valve and extraction line are vacuum-jacketed to minimize boil off losses when transferring liquid as well as helping to protect the operator from coming in contact with extremely cold surfaces.

7.5.1 Removal of the liquid helium extraction line (optional)

The system is supplied with the extraction line installed in the Dewar. When installed, the extraction line will introduce small losses into the Dewar, slightly reducing the liquid helium production rate. The extraction line can be removed during production and re-inserted to withdraw liquid helium.

Follow the steps below to remove the extraction line:

1. Select the **MANUAL OFF** mode on the touch screen (if powered on).
2. Close the helium regulator shut off valve to stop the flow of helium into the Dewar.
3. Open the **0.5 PSIG** atmospheric relief valve to release the pressure in the Dewar.
4. Close the vent valve **when the compound pressure gauge reads 0 PSIG**.
5. Remove the extraction line. **See Figure 7-11a.**
 - Turn the extraction port sleeve counterclockwise with one hand to loosen, and simultaneously pull the extraction line straight up and out with the other hand.
6. Insert the extraction port plug into the extraction port. **See Figure 7-11c.**
7. Hand-tighten the extraction port sleeve.
 - Turn the extraction port sleeve clockwise onto the threads, with the retainer and O-ring assembly in between. **See Figure 7-11b.**

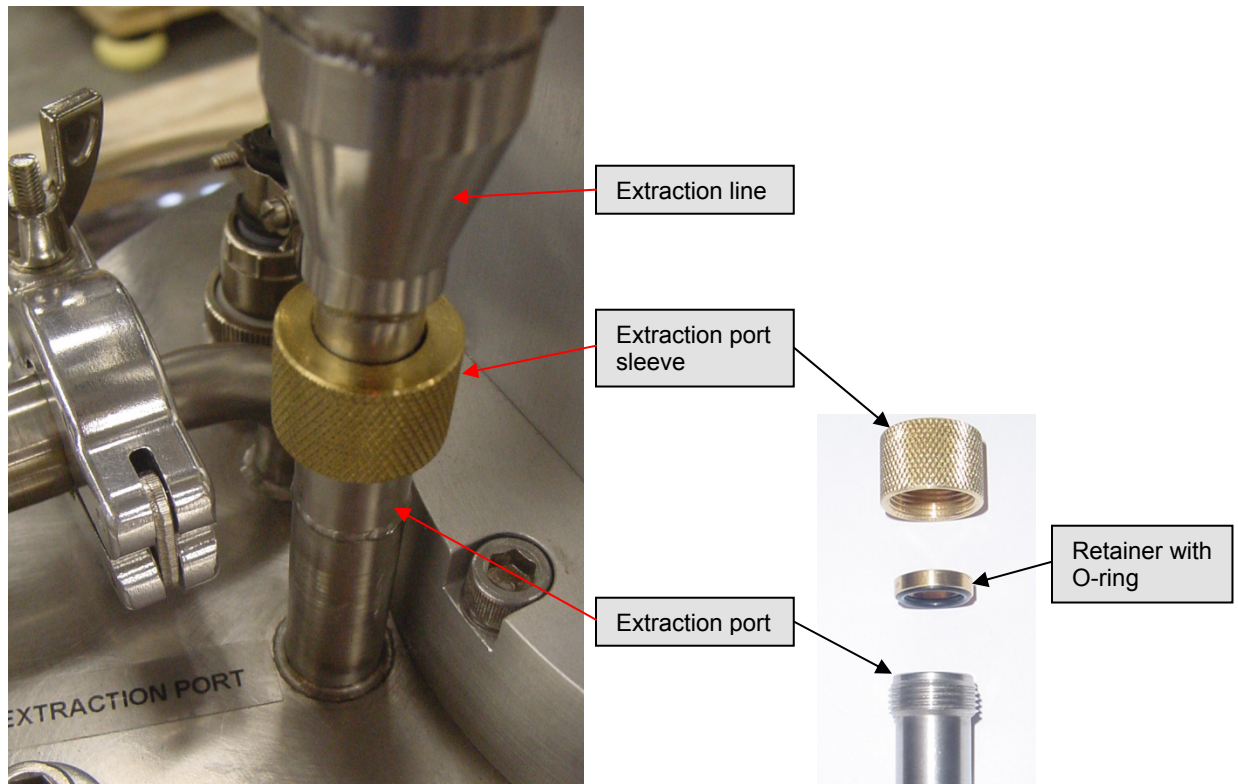

Figure 7-11a: Extraction line installed in Dewar port detail

Figure 7-11b: Extraction

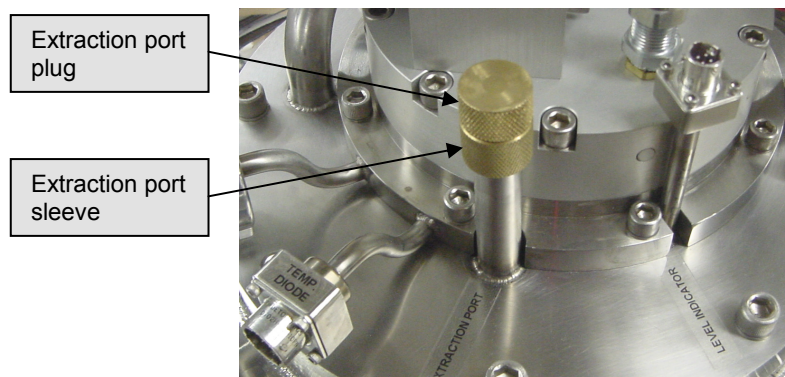

Figure 7-11c: Dewar extraction port

7.5.2 Insertion of the extraction line

To remove liquid helium from the Dewar, the extraction line must be inserted into the Dewar extraction port. Referring to **Section 5.6**, perform the following steps to install the extraction line.

WARNING

The operator should be outfitted with the recommended personal protective equipment outlined above before inserting the extraction line into the Dewar.

1. Select the **MANUAL OFF** mode on the touch screen (if powered on).
2. Close the helium regulator shut off valve to stop the flow of helium into the Dewar.
3. Open the **0.5 PSIG** atmospheric relief valve to release the pressure in the Dewar.
4. Close the vent valve **when the compound pressure gauge reads 0 PSIG**.
5. Remove the extraction line. **See Figure 7-11a.**
 - Turn the extraction port sleeve counterclockwise with one hand to loosen, and simultaneously pull the extraction line straight up and out with the other hand.
6. **Slowly** insert the extraction line withdrawal tube into the extraction port.



INFORMATION

Inserting the withdrawal tube slowly allows the vapor to cool the withdrawal tube, which reduces the amount of liquid helium boil off.

7. Hand-tighten the extraction port sleeve.
 - Turn the extraction port sleeve clockwise onto the threads, with the retainer and o-ring assembly in between. **See Figure 7-11b.**
8. Close the **0.5 PSIG** atmospheric relief valve.
9. **Slowly** open the helium regulator shut off valve to pressurize the Dewar.
10. Open the isolation valve to the vapor pressure controller.
 - When the compound pressure gauge shows a pressure of **1 PSIG** or greater, withdraw liquid helium from the Dewar as outlined in **Section 7.5.3.**

7.5.3 Withdrawal of liquid helium



WARNING

The operator should be outfitted with the recommended personal protective equipment outlined in **Section 7.5, pages 7-14**, before extracting liquid helium.

To remove liquid helium:

1. Open the valve on the extraction line.
 - When the valve is first opened, escaping gas will be heard and a white vapor will exit the end of the extraction line.
 - Liquid helium will not flow from the hose until the internal line of the extraction hose has cooled to liquid helium temperature.
2. Fill an appropriate, insulated container with liquid helium.
3. Close the valve.
 - Do not over-tighten; damage to the valve stem and seat will occur.
 - Once the valve stem contacts the valve seat, light finger pressure is all that is needed to close the valve.
 - A small amount of liquid helium still in the extraction hose will drain.

**CAUTION**

Damage to the valve stem and seat will occur if the valve is over-tightened.

7.5.4 Ice forming on the extraction line

If ice begins to form on the extraction line while transferring liquid, the extraction line may have lost vacuum. Follow the steps below for evacuating the extraction line. Start at **step 1** if extraction line is still installed in the LHeP. Skip to **step 8** if the extraction line has already been removed, and is at room temperature.

1. Press the **Manual** button.
2. Press the **OFF** button.
 - This will switch off the compressor system.
3. Close the helium regulator shut off valve to stop the flow of helium into the Dewar.
4. Close the isolation valve for the vapor pressure controller.
5. Open the vent valve to release the Dewar pressure to the atmosphere.
6. When the compound pressure gauge reads **0 PSIG**, close the vent valve.
7. Remove the extraction line. **See Figure 7-11a.**
 - Turn the extraction port sleeve counterclockwise with one hand to loosen; simultaneously pull the extraction line straight up and out with the other hand.
8. Install the extraction port plug to seal the Dewar.
 - Turn clockwise to tighten the extraction port sleeve.
9. Close the vent valve.
10. **Slowly** open the helium regulator shut off valve to pressurize the Dewar.
11. The LHeP can now be turned back on.
12. Once the extraction line has been allowed to warm to room temperature, locate the **1/2 in operator** that is provided in the Cryomech LHeP tool kit. **See Figure 7-12.**



Figure 7-12: 1/2 in Operator

13. Remove the dust cap from the evacuation port on the extraction line.
14. Install the **operator** onto the **evacuation port**.

- Thread the handle into the evacuation port plug. **See Figure 7-13.**

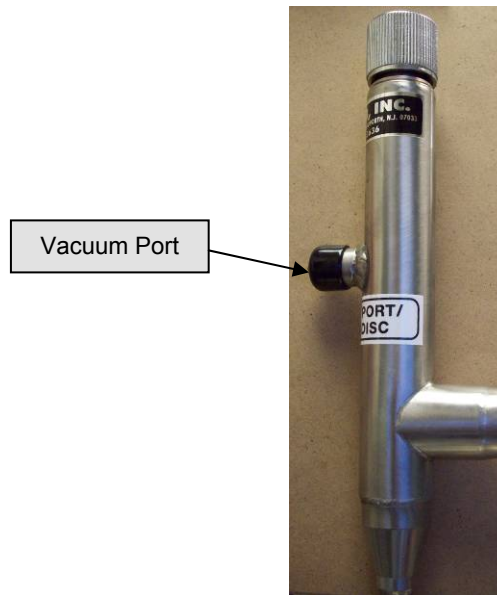

Figure 7-13: Evacuation port

15. Connect a turbo vacuum pump capable of at least 10^{-5} Torr using a vacuum line.
 - The operator has a **KF16** fitting.
16. Evacuate the vacuum line to a value less than 10^{-5} Torr.
17. Pull up on the operator handle to start evacuating the extraction line.
 - Evacuate for more than **8 hours** with the vacuum better than 10^{-5} Torr.
18. Re-install the extraction port plug.
 - Push the operator handle in (toward the threaded end)
 - Unscrew the operator handle
 - Remove the port plug from the operator
19. The vacuum pump can now be turned off.
20. Remove operator once the vacuum has been released in the vacuum line.

7.6 Daily inspections

The liquid helium plant has been designed to give continuous, trouble-free service. There are, however, daily inspections that will help detect and prevent system failure. Observe the following list carefully.



INFORMATION

It is helpful to monitor the liquid helium plant daily in order to detect changes in performance early. These changes can signify degradation in performance that could result from the beginning of a problem that requires attention.

7.6.1 Dewar

Check and record the Dewar pressure. Unless the factory setting was changed, the gauge should read approximately **3 PSIG** when the system is operating and the Dewar is at liquid helium temperature. When the system is **OFF**, the gauge should read **10 PSIG maximum**.

Caution: If the Dewar pressure gauge shows a pressure greater than **15 PSIG**:

1. Close the He regulator shut off valve.
2. Relieve the pressure through the vent valve.
3. The problem must be diagnosed and corrected immediately.
4. Contact Cryomech if the cause of the over-pressurization is not determined.



CAUTION

A Dewar pressure greater than **15 PSIG** indicates a problem with the safety relief valves. The problem must be diagnosed and corrected immediately to prevent damage.

7.6.2 High and low pressure

The high and low pressures should be monitored daily.

Cryomech recommends that you maintain a regular record of the high and low pressure readings, at intervals that make sense for the way you use your system.

Changes in the high and low pressure readings on the compressor gauges are used for diagnosing several different types of problems. It is important to know whether changes are sudden or gradual, and to know how the high and low pressures are changing relative to each other.

7.6.3 Cold head temperature

Temperature changes are also a key diagnostic, in addition to pressure fluctuations.

A temperature sensor is attached to the cold head helium condenser.

Cryomech recommends that you keep a regular record of the temperature at intervals that make sense for the way you use your system.

7.6.4 Cooling water input and output

Cryomech recommends keeping a regular record of the input and output cooling water temperatures and flow rates, if possible.

7.7 Disassembling the system for transport or storage

Use the following steps to prepare a Cryomech Liquid Helium Plant for eventual transport or storage. Assure that the plant is packaged in an appropriate container and/or stored in an acceptable location.

7.7.1 Helium compressor

1. The front panel display on the compressor system will indicate **OFF**.
2. Disconnect the power to the system.
 - Switch the front panel breakers to the **OFF** position.
3. Disconnect the main power to the system.
 - Switch the dedicated circuit breaker to the **OFF** position.
4. Disconnect the power cord from the external breaker panel.
 - Coil up the power cord in preparation for transport or storage.
5. Turn **OFF** the water supply at the source.
6. Disconnect the supply.
7. Drain quick connect couplings from the compressor's inlet and outlet fittings.
 - To disconnect the couplings, pull the collar back. **See Figure 7-14.**

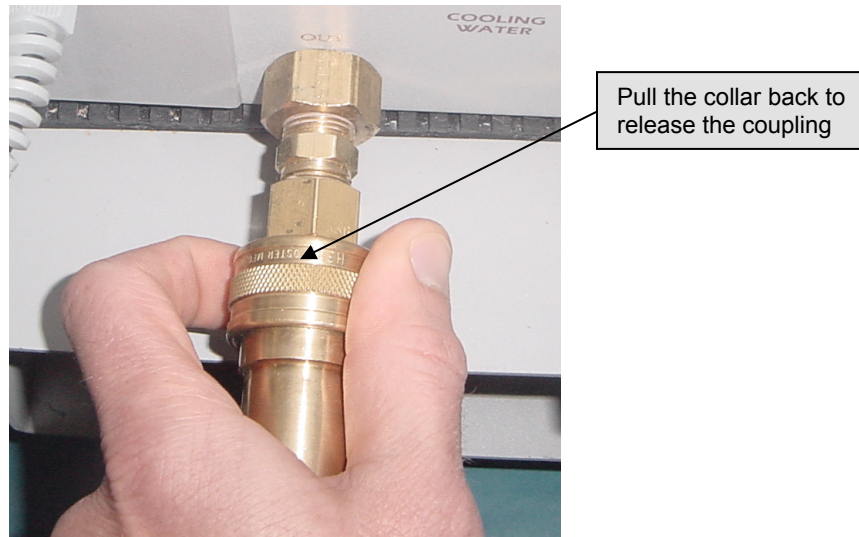

Figure 7-14: Disconnecting the cooling water quick connect coupling

7.7.2 Dewar

1. Close the helium regulator shut off valve.
2. Turn **OFF** helium supply to the Dewar.
3. Disconnect the helium supply line quick connect coupling from the Dewar quick connect coupling, attached to the He inlet regulator.
 - Push the flared section of the female coupling towards the red collar on the male coupling to unlock and separate them. **See Figure 7-15.**

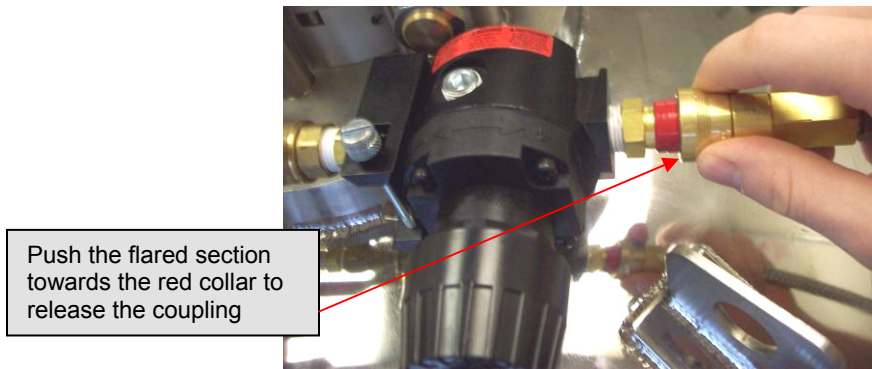

Figure 7-15: helium supply quick connect coupling

7.8 Troubleshooting

7.8.1 Helium compressor will not start

PROBLEM	Helium compressor will not start.
POSSIBLE CAUSE	<ul style="list-style-type: none"> a. No power supplied to the helium compressor. b. Circuit breaker OFF. c. Compressor Error message on display screen.
SOLUTION	<ul style="list-style-type: none"> a. Verify the power supply to the helium compressor and ensure it meets the requirements outlined in Section 5. b. Turn both circuit breakers (located on the front panel of the compressor package) ON. c. Refer to Section 7.8.7 for error message diagnostics.

7.8.2 Helium compressor starts, no pressure fluctuation

PROBLEM	Helium compressor starts, no bounce in the pressure gauges, diode temperature not decreasing.
POSSIBLE CAUSE	<ul style="list-style-type: none"> a. Cold head motor cord not connected to the cold head and/or to the compressor package. b. Aeroquip® connector(s) not completely tightened. c. High and low pressure helium flex lines reversed.
SOLUTION	<ul style="list-style-type: none"> a. Press the Manual button. Press the OFF button to turn the compressor off. Connect the cold head motor cord to the cold head and/or to the compressor package. b. Tighten all Aeroquip® connectors. c. Verify that one of the helium flex lines connects the high pressure port on the helium compressor package to the high pressure port on the cold head, and that the other helium flex line connects the low pressure ports.

7.8.3 System shut down

PROBLEM	System automatically shut down.
POSSIBLE CAUSE	<ol style="list-style-type: none"> Circuit breaker tripped. Interruption of the power supply to the compressor package. Compressor Error message displayed on front panel screen.
SOLUTION	<ol style="list-style-type: none"> Reset the circuit breaker on the front panel of the helium compressor. See Section 5. Check the power supply to the system and verify that it meets the requirements outlined in Section 5. Refer to Section 7.8.7 for error message diagnostics.

7.8.4 LHeP not performing to liquefaction specification

PROBLEM	Liquid helium plant not liquefying to specification.
POSSIBLE CAUSE	<ol style="list-style-type: none"> Gaseous helium supply does not meet specification. Level indicator set to incorrect operating mode.
SOLUTION	<ol style="list-style-type: none"> Transfer all the liquid helium out of the Dewar and allow it to warm up to room temperature. Then, evacuate the Dewar per the Dewar evacuation and charging procedure in Section 8 of this manual. Confirm that the level indicator is not operating in continuous mode. If it is in continuous mode, change the indicator to operate in sample/hold mode. This prevents the level indicator from supplying a continuous current to the level probe which will decrease the production rate of the LHeP. The procedure for changing modes can be found in Section 5.6.1.

7.8.5 Liquid level monitor display reads “Open”

PROBLEM	Display reads “Open” instead of a liquid helium level.
POSSIBLE CAUSE	<ol style="list-style-type: none"> Sensor not connected. Connection is broken in the current path.
SOLUTION	<ol style="list-style-type: none"> Ensure the level monitor cable is properly connected to the level monitor and Dewar, as outlined in Section 6. Press Force Sample button on the touch screen to check the connection. Please contact Cryomech for instructions on checking for a broken connection. Contact information can be found on page 1.

7.8.6 Compressor display screen description

The following messages may be displayed on the top line of the compressor display screen. See Figure 5-5 in Section 5 of this manual.

Top line message on the display screen	Message description
COMPRESSOR OFF	Compressor is OFF .
COMPRESSOR ON	Compressor is ON .
STARTING...WAIT x* *x is a number, counting down in seconds; when x is zero, compressor will start.	Compressor ON request received. Compressor will start within 10 seconds unless an error occurs, or a stop request is received. This message will show only when the compressor has not been OFF for more than 10 seconds and a start request is received. This state allows the high and low helium pressures to balance.
WAITING FOR POWER	Compressor is waiting for power. This display will remain for a short time while the power tracking state machine is checking the line power, which takes 5 seconds minimum. WHEN POWER COMES BACK, THE COMPRESSOR WILL START.
COMPRESSOR ERROR	An error has occurred. The error will display on the second line of the compressor display screen as well as on the touch screen warnings box. If more than one error is logged, the highest priority error will be displayed on screen. See Section 7.8.7 for error display and description.
ERR HOLD...WAIT x* *x is a number, counting down in seconds; when x is zero, compressor will start.	Compressor ON request received and compressor will start in x seconds unless an error occurs or a stop request is received. This message will show when the compressor has encountered certain errors that require a minimum OFF time.
CALL FACTORY	The compressor has entered a locked-out state due to experiencing 6 errors within one hour . The compressor cannot be restarted until a code is entered. Contact Cryomech to obtain this code. Have the CPU serial number and compressor hours ready – both are stored in the SERVICE menu. The lockout contributors are noted in Section 7.8.7 .
ERROR! NO MESSAGE!	This message should never be seen. It indicates the compressor is in a state with no description available.

Section 8

Routine Maintenance

Section 8: Routine Maintenance

8.1 Introduction

This section contains basic, essential, maintenance information. For more detailed information, please contact Cryomech, Inc.

8.2 Maintenance schedule

Maintenance	Frequency	Comment
Replace adsorber	Every 20,000 hours	See Section 8.4
Vent helium gas from the compressor	As required	See Section 8.5
Charge helium gas to the compressor	As required	See Section 8.6
Dewar evacuation and charging	As required	See Section 8.7

8.3 Cold head



CAUTION

The cold head contains no user-serviceable parts. *Attempting to disassemble the cold head will void the warranty.*

CONTACT CRYOMECH TO RETURN THE COLD HEAD FOR SERVICING.

8.4 Replace the adsorber

Required tools:

Quantity	Description	Comment
1	1" open end wrench	For Aeroquip® coupling
1	1-1/8" open end wrench	For Aeroquip® coupling
1	1-3/16" open end wrench	For Aeroquip® coupling
1	1-3/8" open end wrench	For Aeroquip® coupling
1	1-5/8" open end wrench	For Aeroquip® coupling
1	Flat-head screwdriver	For hose clamp
1	Phillips-head screwdriver	For side panel of compressor



CAUTION

At no time should the Aeroquip® couplings be removed from the adsorber. Replacement can be completed without relieving system pressure, since the adsorber is equipped with Aeroquip® couplings for sealed removal.

1. Shut down the system.
 - a. Press the **Manual** button.
 - b. Press the **OFF** button.
 - c. Switch **OFF** the circuit breakers mounted on the front-panel to shut down the entire system.
 - d. Disconnect the input power from the compressor package.
2. Disconnect both rigid lines from the compressor and external volume housing.
 - When loosening the Aeroquips®, alternate between the compressor and external volume housing Aeroquip® couplings to remove the line evenly.
 - **See Figure 8-1.**

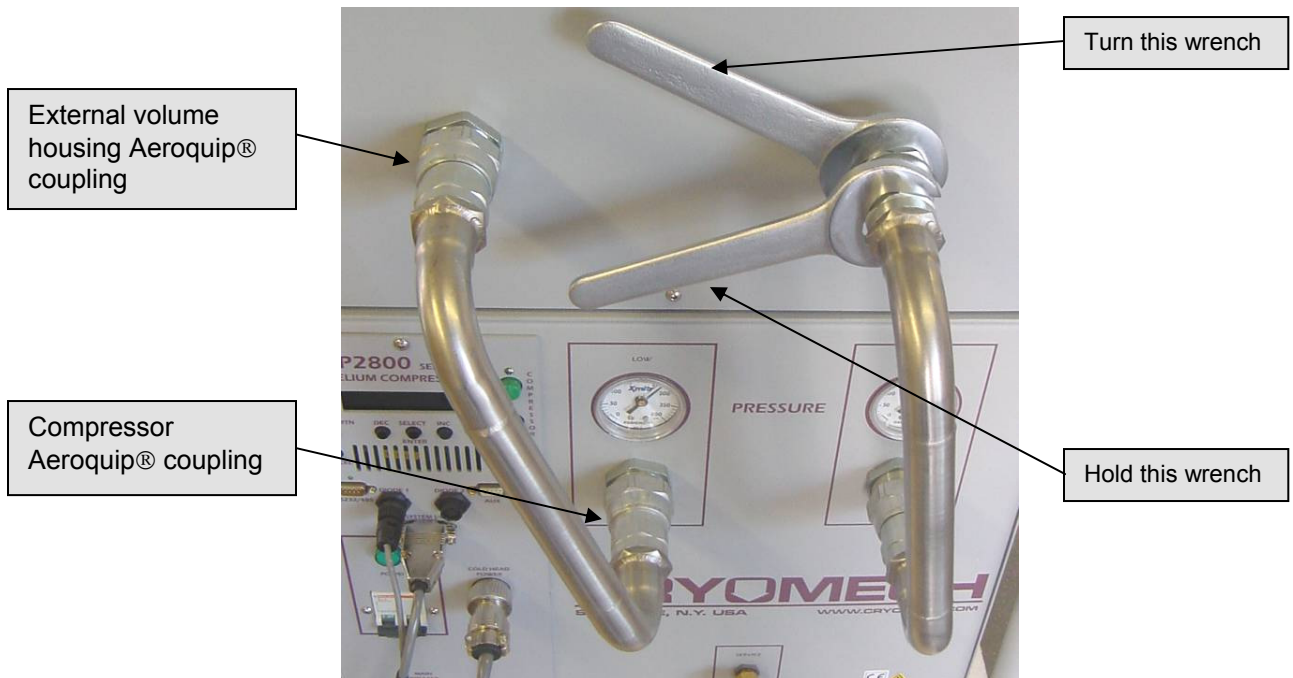

Figure 8-1: Rigid lines from the compressor and volume housing

3. Disconnect the female Aeroquip® couplings from the compressor
 - Pivot them away from the male couplings.
 - **See Figure 8-2.**



Aeroquip® couplings completely disconnected and pivoted away

Figure 8-2: Aeroquip® couplings disconnected from the compressor

4. Remove the side panel from the right-hand side of the compressor package.
 - Remove the 6 quarter-turn screws and retain them.
 - Pull the panel away from the compressor package.



WARNING

The input power must be disconnected from the helium compressor package before removing any helium compressor package panels.

5. Disconnect the Aeroquip® coupling between the adsorber and the oil separator.
 - Use three wrenches, as shown in **Figure 8-3.**

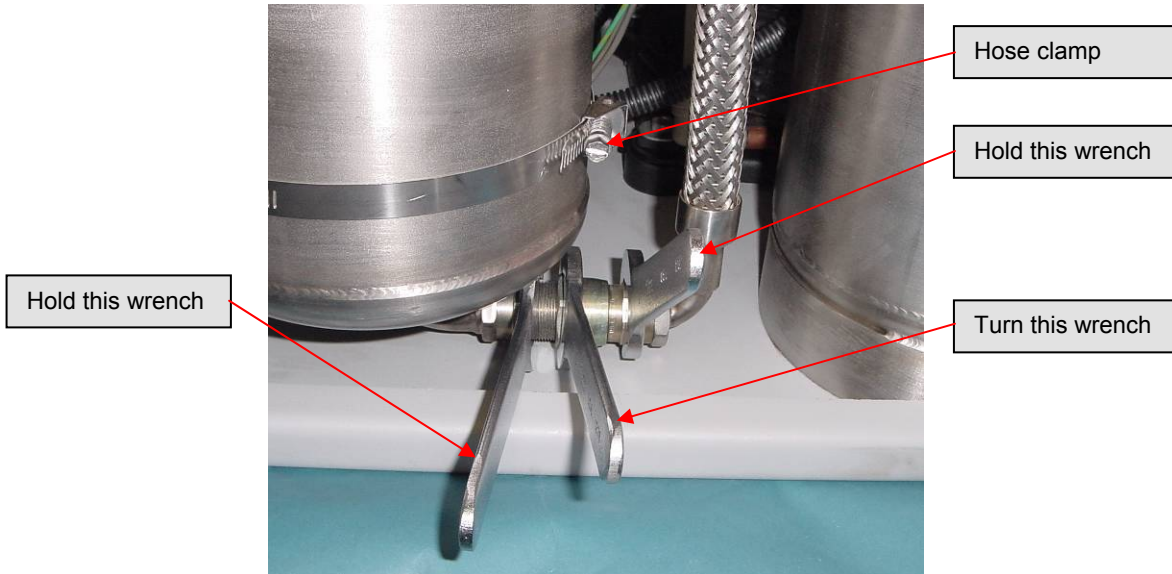

Figure 8-3: Disconnecting the adsorber Aeroquip®

6. Remove the nut holding the high-pressure Aeroquip® coupling to the front panel.
7. Loosen and disconnect the hose clamp attaching the adsorber to the front panel.
8. Remove the adsorber from the compressor package.
9. Check the Aeroquip® couplings for oil residue.
 - If oil is present, contact Cryomech for further assistance.
10. Remove the lock washer from the top Aeroquip®
11. Install it on the new adsorber.
 - To install the new adsorber, reverse steps 5 through 8.
12. Reconnect both rigid lines to the compressor and external volume housing.
13. Reattach the side panel to the compressor package.

8.5 Vent excess helium from the compressor

Required tools:

Quantity	Description	Comment
1	3/4" open end wrench	For Aeroquip® coupling
1	Service Aeroquip® coupling	For service access port



CAUTION

Venting more than **5 PSIG (.34 bar)** of helium per minute will lead to improper oil migration within the system. If this condition occurs, factory service will be required.

This procedure should only be used to vent small quantities of helium from an overcharged system.

1. Make sure the service valve is closed. **See Figure 8-4.**
2. Attach the small service Aeroquip® coupling to the service access port.
3. **Slowly** open the service valve.
 - Do not vent more than **5 PSIG (.34 bar)** of helium per minute.
4. Close the service valve.
5. Remove the service Aeroquip® from the service access port.

8.6 Recharge helium to the compressor

Required tools and equipment:

Quantity	Description	Comment
1	3/4" open end wrench	For Aeroquip® coupling
1	Service Aeroquip® coupling	For service access port
1	Vacuum/charging system	For adding helium



CAUTION

When adding helium to the compressor, the helium must be **99.999%** pure. Contamination by other gases will result in the freezing of the contaminant gases in the cold head, because their freezing temperature is much higher than that of helium. Contaminants in the helium charge will severely degrade the cold head function and it will require factory servicing.

Contamination of the helium by other gases is a common cause of premature failure and, unless resulting from a system failure, is not covered by the warranty.

This procedure should be performed with the compressor package **OFF**. Adding helium is possible whether or not the cold head is attached to the compressor package. Both the service access and service valve are connected to the low-pressure manifold of the compressor.

1. Turn the system **OFF**.
2. Allow the entire system (both the compressor package and the cold head) to come to room temperature.
3. Use only high purity helium with a minimum purity of **99.999%**.
4. The helium source and regulator should be capable of pressurizing to the desired pressure.
5. Make sure the service valve is closed.
6. Attach the service Aeroquip® coupling to the service access port. **See Figure 8-4.**

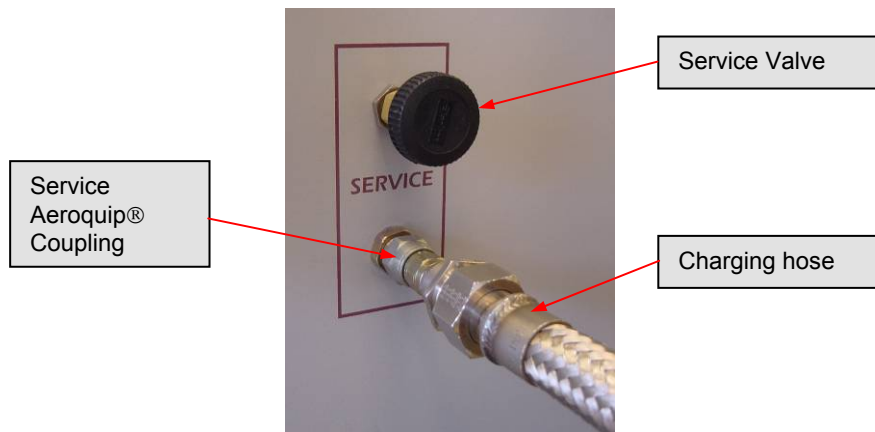

Figure 8-4: Service valve and access port

- 7. Attach a charging line from the service Aeroquip® to a typical vacuum/charging system as shown in **Figure 8-5** and **Figure 8-6** below.

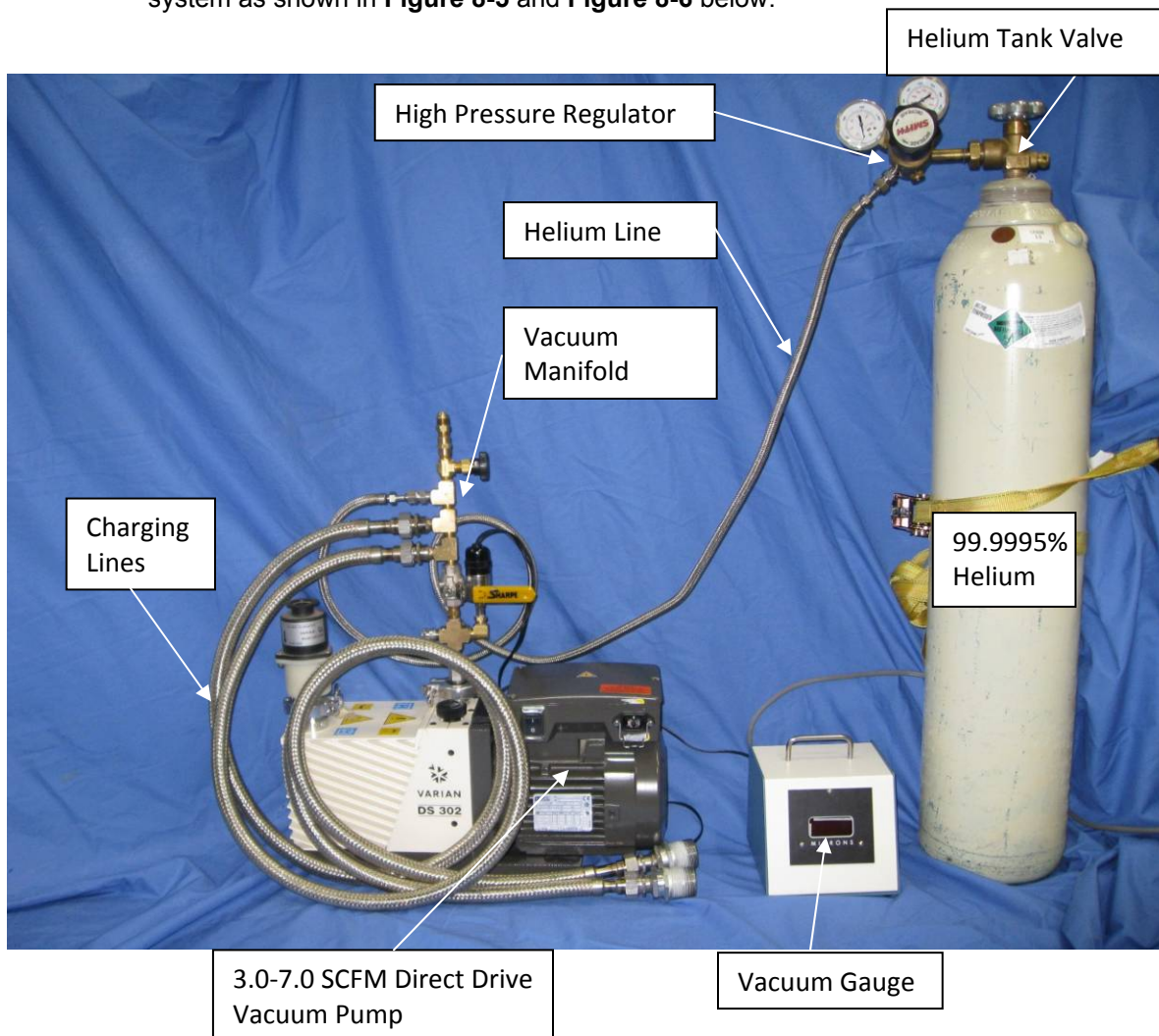

Figure 8-5: Vacuum/charging system

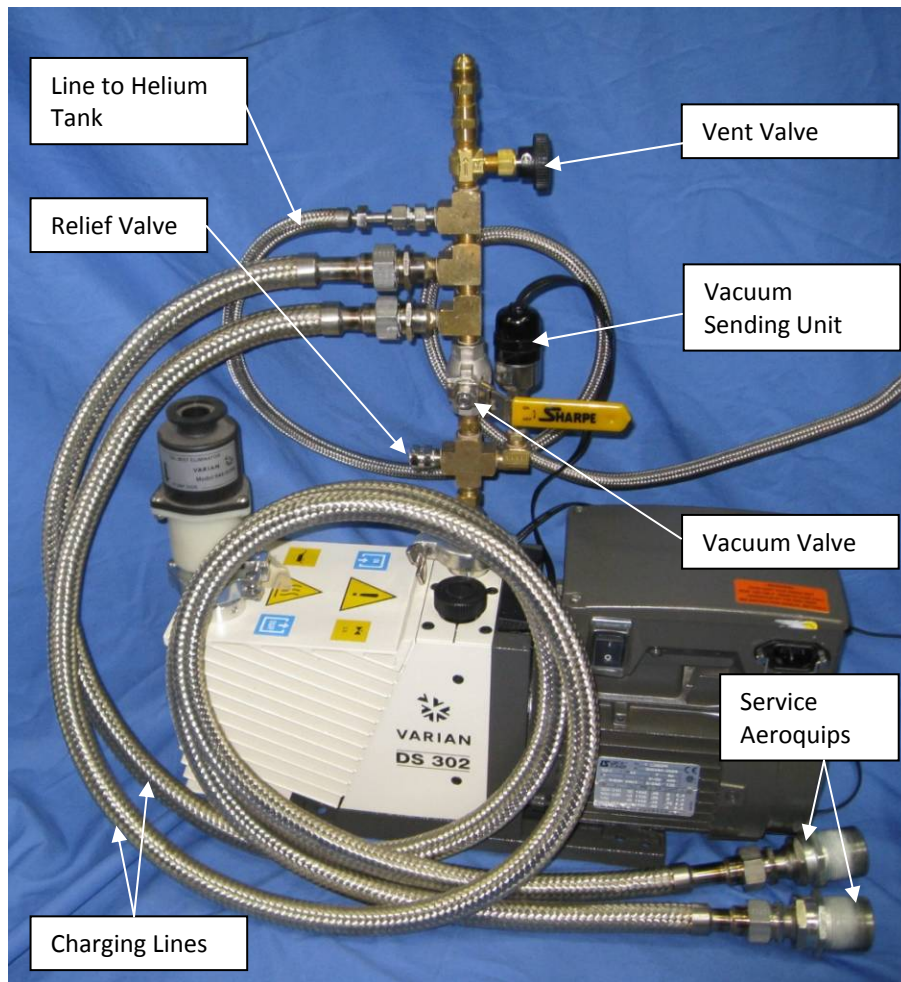

Figure 8-6: Close up of vacuum/charging manifold and pump

8. Evacuate to **50 microns**.
9. Isolate the vacuum pump and add **50 PSIG (3.4 bar)** of helium.
10. Vent the helium.
 - Repeat **steps 8 & 9** at least once.
 - Continue to **step 11**.
11. Final evacuation should be to **25 microns**.
12. Pressurize the line to the service access with the desired amount of helium pressure.
13. **Slowly** open the service valve to add helium to the system.
 - The final helium charge in the system is specified in **Section 5**.



CAUTION

No more than **5 PSIG (.34 bar)** of gas should be added per minute to prevent internal oil contamination to the system. If such contamination occurs, factory service will be required.

14. Close the service valve.
15. Remove the service Aeroquip® from the service access.

8.7 Dewar evacuation and charging

Required tools and equipment:

Quantity	Description	Comment
1	Vacuum/charging system	For evacuating and adding helium
1	Evacuation/charging line	For connection between dewar and vacuum/charging system

Before starting the system, check the dewar compound pressure gauge. If the gauge reads **0 PSIG** or less, the dewar must be evacuated and charged with helium before use.



CAUTION

Failure to evacuate and charge the dewar will contaminate the condensing surfaces and decrease the liquid helium production. *The warranty does not cover this type of damage.*

1. Select **Manual OFF** mode on the touch screen computer.
2. Close the helium inlet valve
3. Close both vapor isolation valves.
4. Attach an evacuation/charging line to the dewar evacuation valve.
 - The valve is fitted with a **KF16** flange.
5. Attach the opposite end of the evacuation/charging line to a typical vacuum/charging system as shown in **Figure 8-5**.
6. Open the dewar evacuation valve completely.
7. Start the vacuum system and evacuate the dewar to approximately **30 in Hg**.
8. Isolate the vacuum pump and charge the dewar with approximately **4 PSIG (0.28 bar)** of helium, with a minimum purity of **99.99%**.



CAUTION

The helium supply to the dewar must have a purity of **99.99%** or greater. Helium purities less than **99.99%** will contaminate the condensing surfaces and decrease the production of liquid helium. *The warranty does not cover this type of damage.*

9. Close the dewar evacuation valve.
10. **Slowly** open the helium inlet valve.
11. Shut off the vacuum system.
12. Disconnect the evacuation/charging line from the evacuation valve.

8.8 Cleaning

8.8.1 Compressor package, cold head, and dewar

The compressor package, cold head, and dewar require no cleaning other than wiping the outside of each if it becomes dusty or dirty.



CAUTION

Never wet any part of the system. *Water getting into the system will void the warranty.*

8.8.2 Aeroquip® couplings



WARNING

Never remove an Aeroquip® coupling from the helium flex lines, cold head, adsorber, or compressor without first relieving the helium charge. The pressure in any of the components can blow off the coupling with sufficient force to cause injury.

If operated in a clean environment, the only parts of the cryorefrigerator system that are likely to require cleaning are the Aeroquip® couplings. The mating surfaces of the Aeroquip® couplings can get particles on them when the helium flex lines or rigid lines are detached from the compressor package, volume housing, or the cold head.

If an Aeroquip® coupling needs cleaning:

- Wipe the mating surfaces of the coupling with a dry, lint-free cloth.
- Blow off the coupling with clean, dry compressed air.
- **Solvents should never be used.**
 - If any grease or oil gets on the Aeroquip® coupling, contact Cryomech.

8.9 Manufacturer only parts

The following parts are available only from Cryomech:

A. Helium flex lines

If the helium flex lines become damaged and need to be replaced, new ones must be obtained from Cryomech.

B. Adsorber

The adsorber needs to be replaced after every **20,000 hours** of use. **See Section 8.4** for instructions on replacing the adsorber.

C. Cold head

The cold head contains no user-serviceable parts and must be serviced by Cryomech authorized technicians. *Attempting to disassemble the cold head will void the warranty. See Section 8.3.*

D. Touch screen computer

If the touch screen computer becomes damaged, a replacement should be obtained from Cryomech.

E. Main power cord

If the power cord becomes damaged, a replacement should be obtained from Cryomech.

F. Cold head motor cord

If the cold head motor cord becomes damaged, a replacement must be obtained from Cryomech.

G. Liquid level monitor cables

If the liquid level monitor cables become damaged, a replacement must be obtained from Cryomech.

H. Dewar pressure controller cables

If the dewar pressure controller cables become damaged, a replacement must be obtained from Cryomech.

I. Diode cable

If the diode cable becomes damaged, a replacement must be obtained from Cryomech.

Appendix A

Cold Head Drawing CMAS Menu System

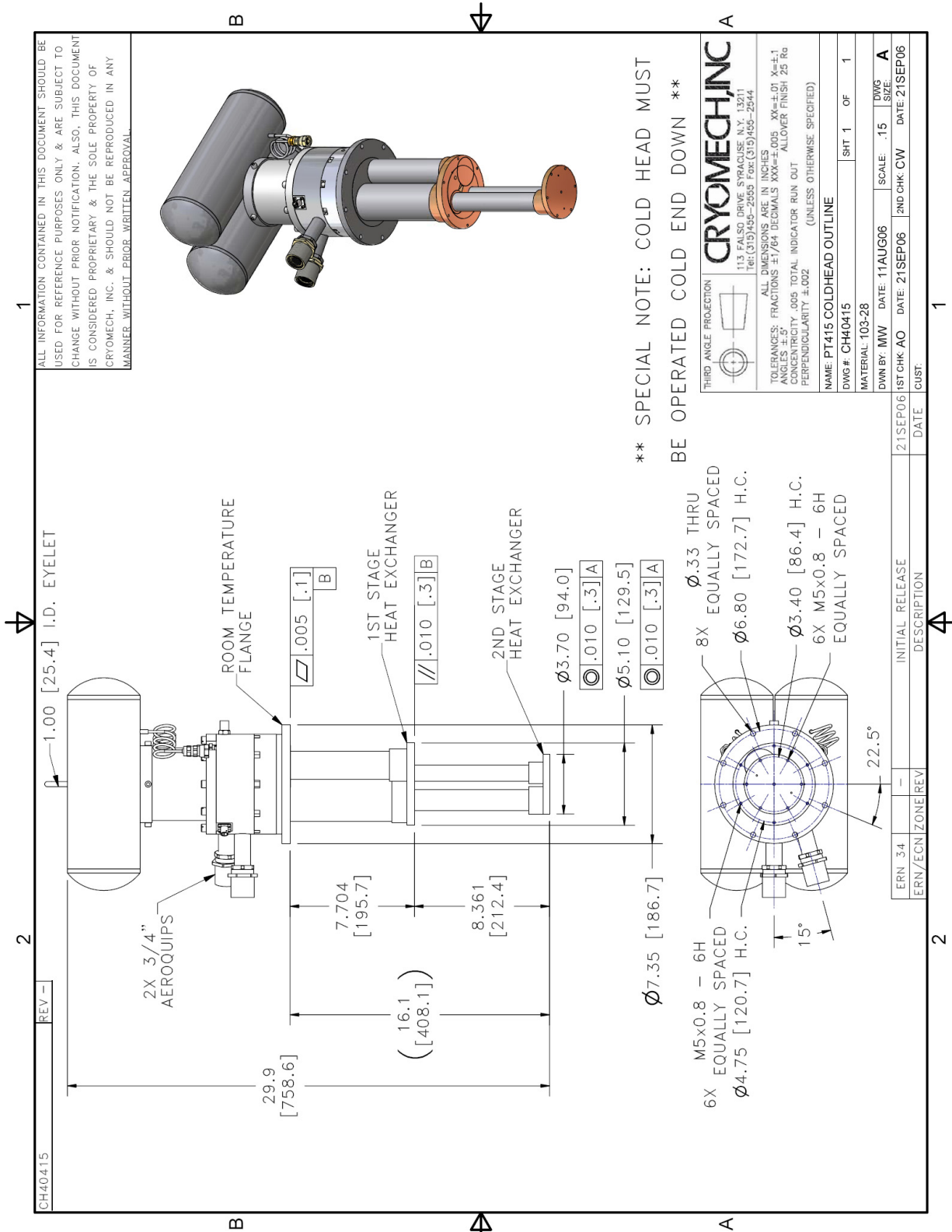

Figure A-1: Cold Head Drawing

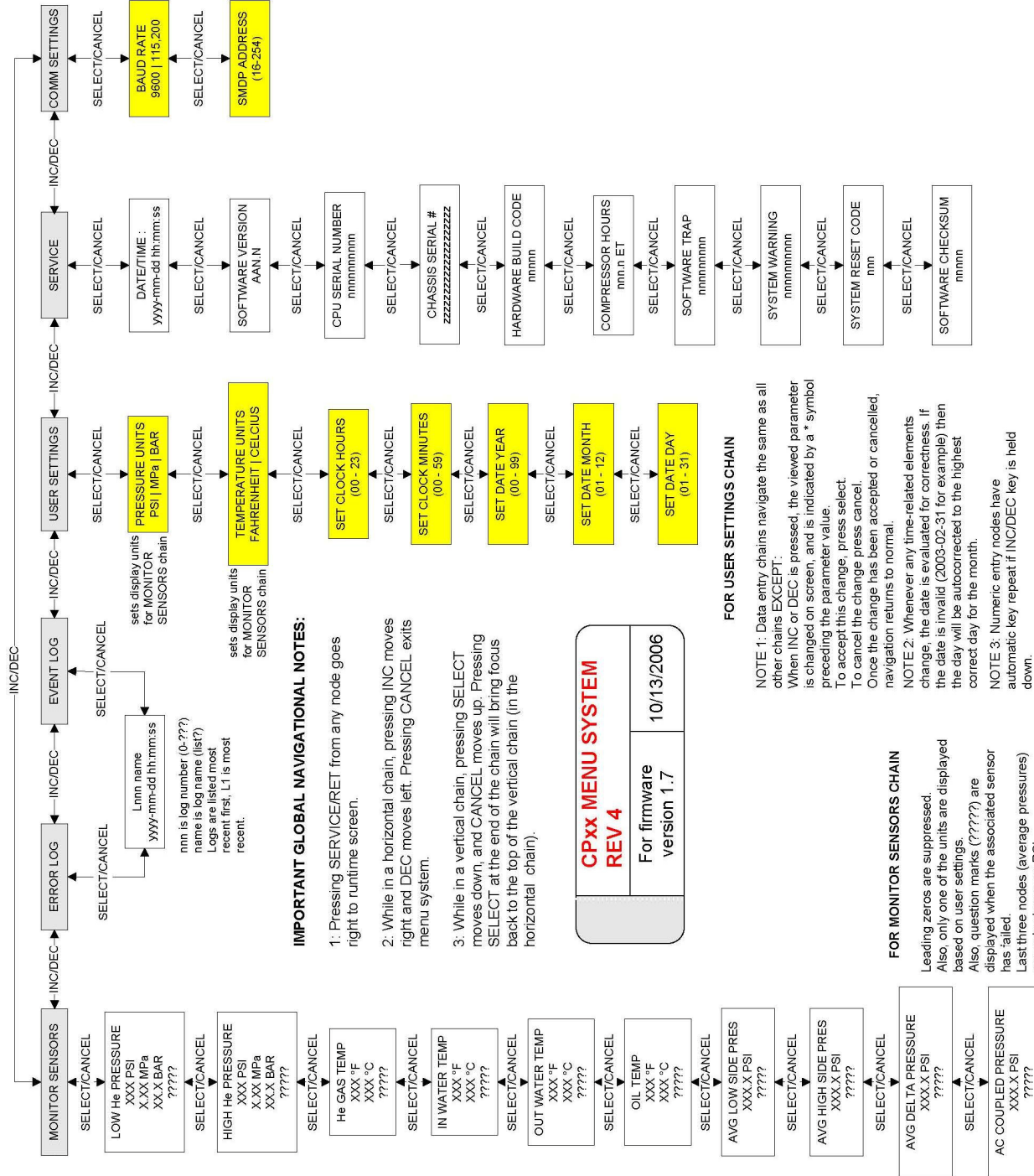

Figure A-2: CMAS Menu System